



Clark Electric Cooperative

Greenwood, WI

Distributed Generation

Information Book

20 kW or Less

Your Touchstone Energy® Partner



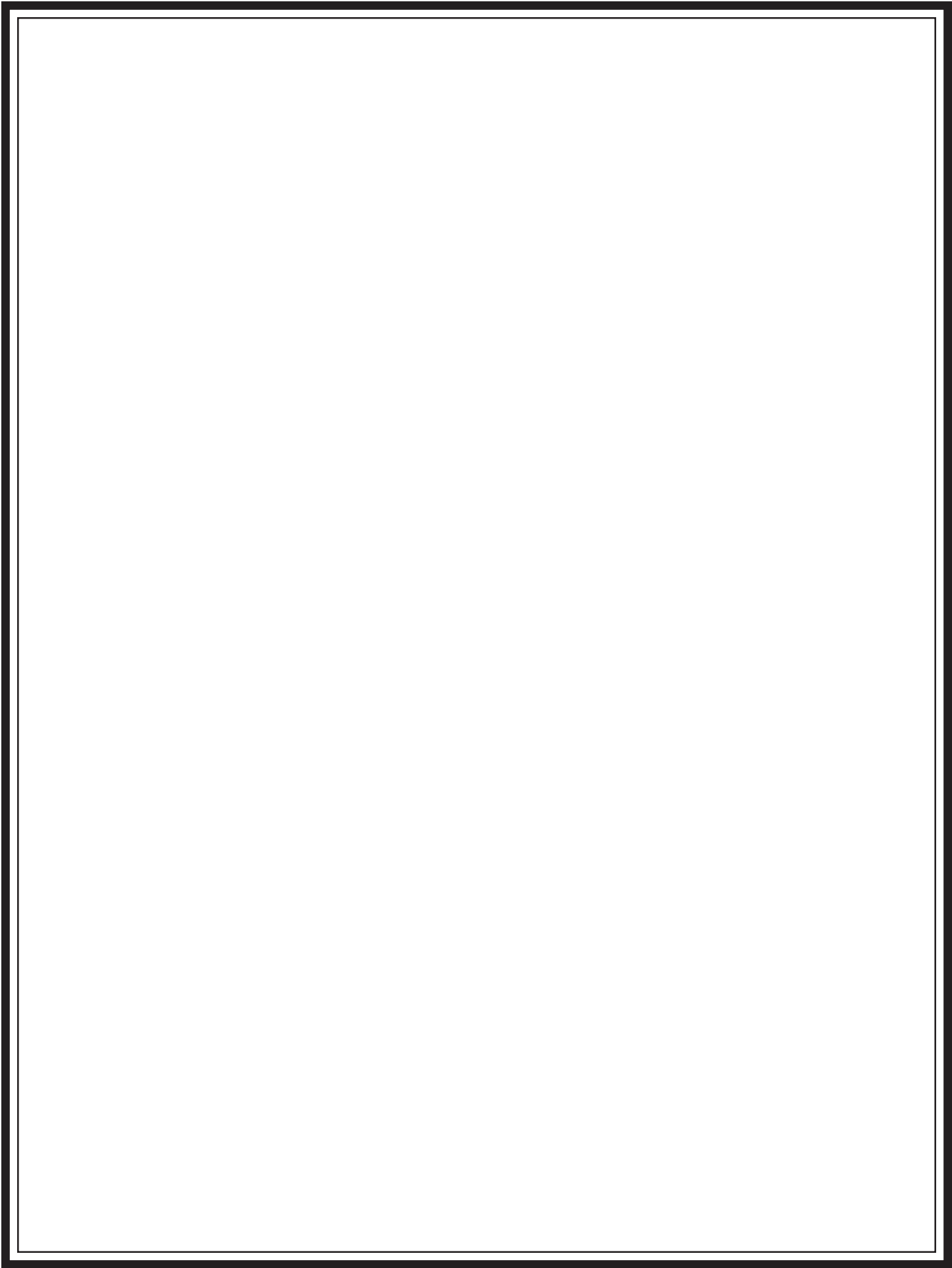



Clark Electric Cooperative

Greenwood, WI

Table Of Contents

- 1 DG Fact Sheet
- 2 DG Application Flow Chart
- 3 DG Application Form
- 4 DG Interconnection Agreement
- 5 Wisconsin DG Interconnection Guidelines
- 6 DG One-line Schematic Diagram
- 7 Chapter PSC 119 - Rules For Interconnection Of DG Facilities

Your Touchstone Energy® Partner



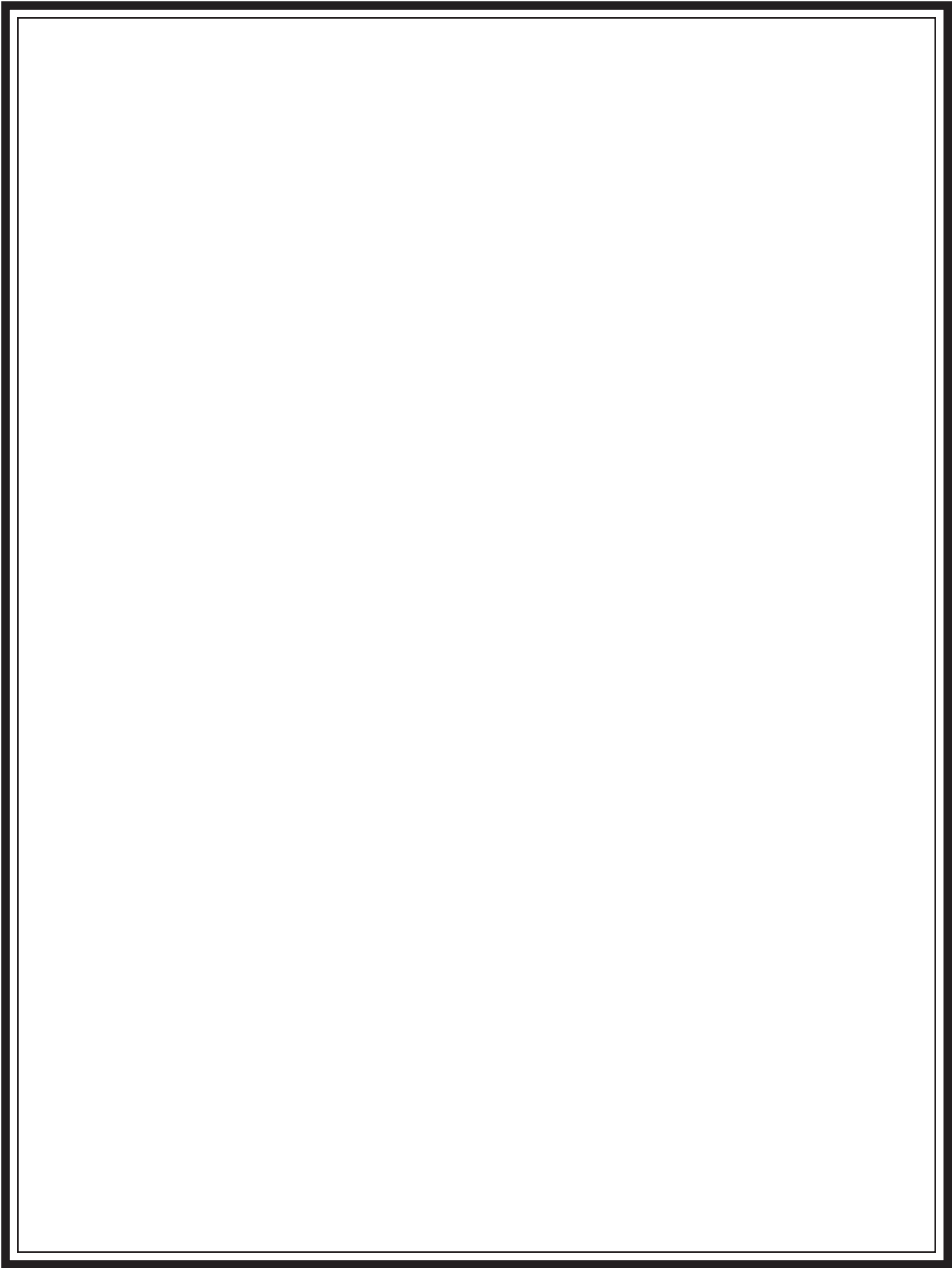



Clark Electric Cooperative

Greenwood, WI

DG Fact Sheet

Your Touchstone Energy® Partner



Customer-Owned Distributed Generation

Prepared by Clark Electric Cooperative

November 2004

Guiding principles

First and foremost, the cooperative will emphasize:

1. **Safety.** Taking all necessary precautions to ensure the safety of the cooperative's employees.
2. **Reliability.** Performing necessary tasks to protect and maintain the reliability and integrity of the power grid.
3. **Cost Fairness.** Operating with fairness to other member-consumers of the cooperative from a cost causation point of view.

Recommended process for consumers

See Flow Chart

Member-consumer / cooperative responsibilities

- The cooperative and the member-consumer must work together in connecting distributed generation to the grid.
- The cooperative and member-consumer must follow any applicable federal or state laws or regulations.
- A written agreement between the cooperative and the member-consumer is required to facilitate a safe, reliable, and fair connection of the facility to the grid.

| Issue | Required | Responsibility |
|-----------------------|----------|-------------------------------|
| Application | Yes | Member-consumer |
| Insurance | Yes | Member-consumer |
| Written Agreement | Yes | Cooperative & Member-consumer |
| Interconnection | Yes | Cooperative |
| Interconnection Costs | Yes | Member-consumer |
| Inspection | Yes | Cooperative & Member-Consumer |
| Service, Maintenance | Yes | Member-consumer |

Written agreement

A written agreement shall address the following items:

- Cooperative representatives must be allowed access to the facilities for purpose of inspecting or testing member-consumer's equipment, facilities, or apparatus and the accuracy of the cooperative's metering equipment.
- The member-consumer and the cooperative will have access to the interconnection switch at all times and the interconnection will be provided with a switch that provides a visible break or opening. The switch must be capable of being padlocked in the open position.
- Communication indicating that the member-consumer is responsible for the costs of installation and maintenance of power factor correction capacitors required to maintain the equivalent of an average power factor of 90 percent (lagging) at the interconnection.
- A requirement that the member-consumer's electric generating equipment be designed, operated and maintained in a manner which does not adversely affect the cooperative's voltage wave form.
- Acknowledgement that the member-consumer is responsible for costs incurred by the cooperative for connection of the facility.
- Acknowledgement that the member-consumer agrees to insure and indemnify the cooperative and its representatives against liability for any injuries or damages caused by the operation of the facility. This typically requires the member-consumer to maintain liability insurance or other proof of financial responsibility.
- Acknowledgment that the member-consumer will regularly inspect, maintain, and service the facility for safe and reliable operation and maintain a record or log.
- Acknowledgement that the member-consumer's facility will be subject to disconnection without notice by the cooperative in the event the facility causes unacceptable safety, voltage, or frequency conditions, service interruption, or communications interference.
- Acknowledgement that the member-consumer will furnish and install an over-current device on the facility to automatically disconnect the facility at all currents that exceed the full-load current rating of the facility.
- Acknowledgement that the member-consumer facility will be equipped with automatic disconnection upon loss of electric voltage supplied by the cooperative.

For more information contact:

Mike Ruff, Director of Operations
Clark Electric Cooperative
124 N. Main St.
PO Box 190
Greenwood, WI 54437-0190
Ph: 715-267-6188 or 800-279-6188

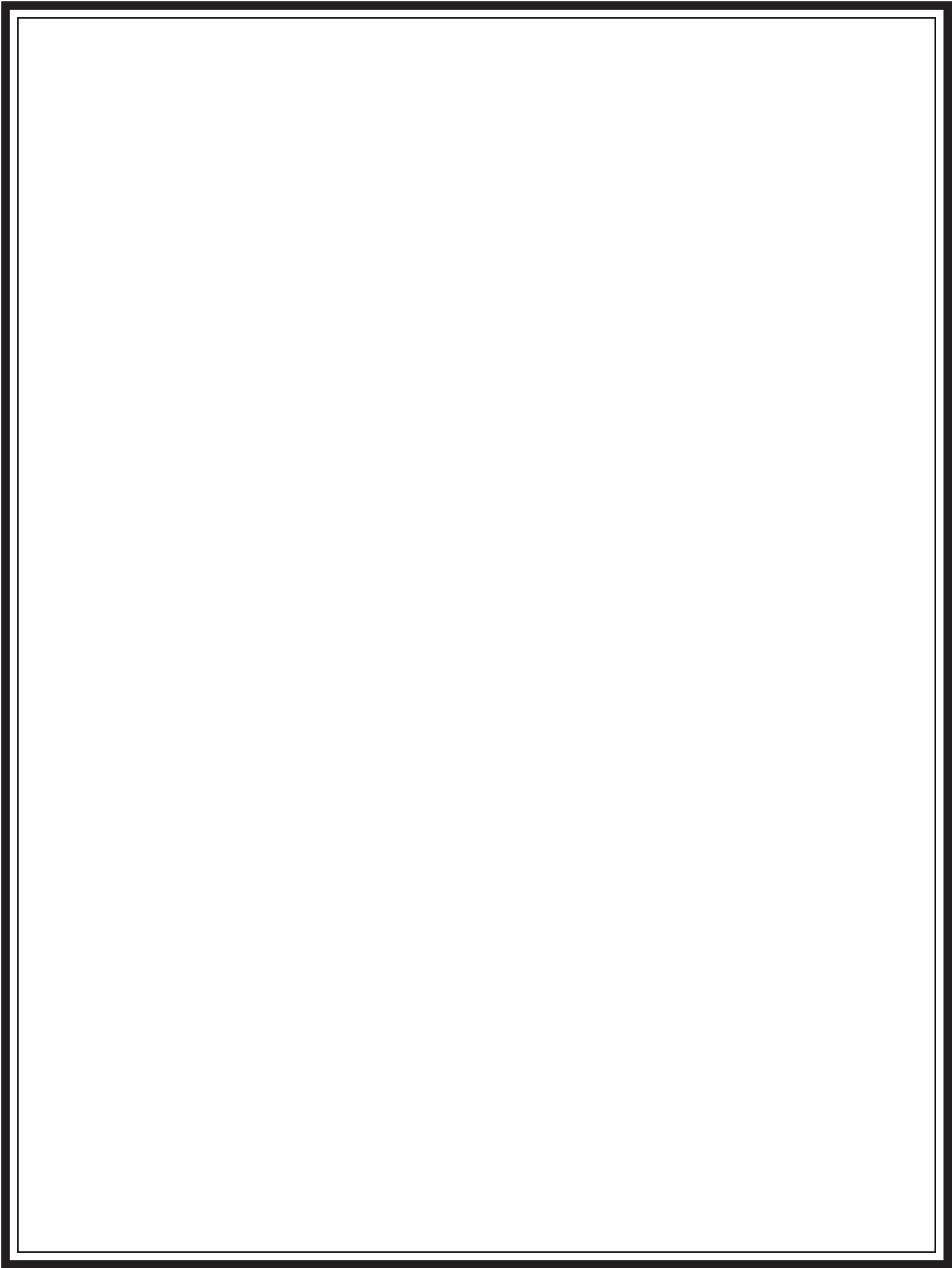



Clark Electric Cooperative

Greenwood, WI

DG Application Flow Chart

Your Touchstone Energy® Partner



Application Process Flow Chart for Interconnecting DG Facilities

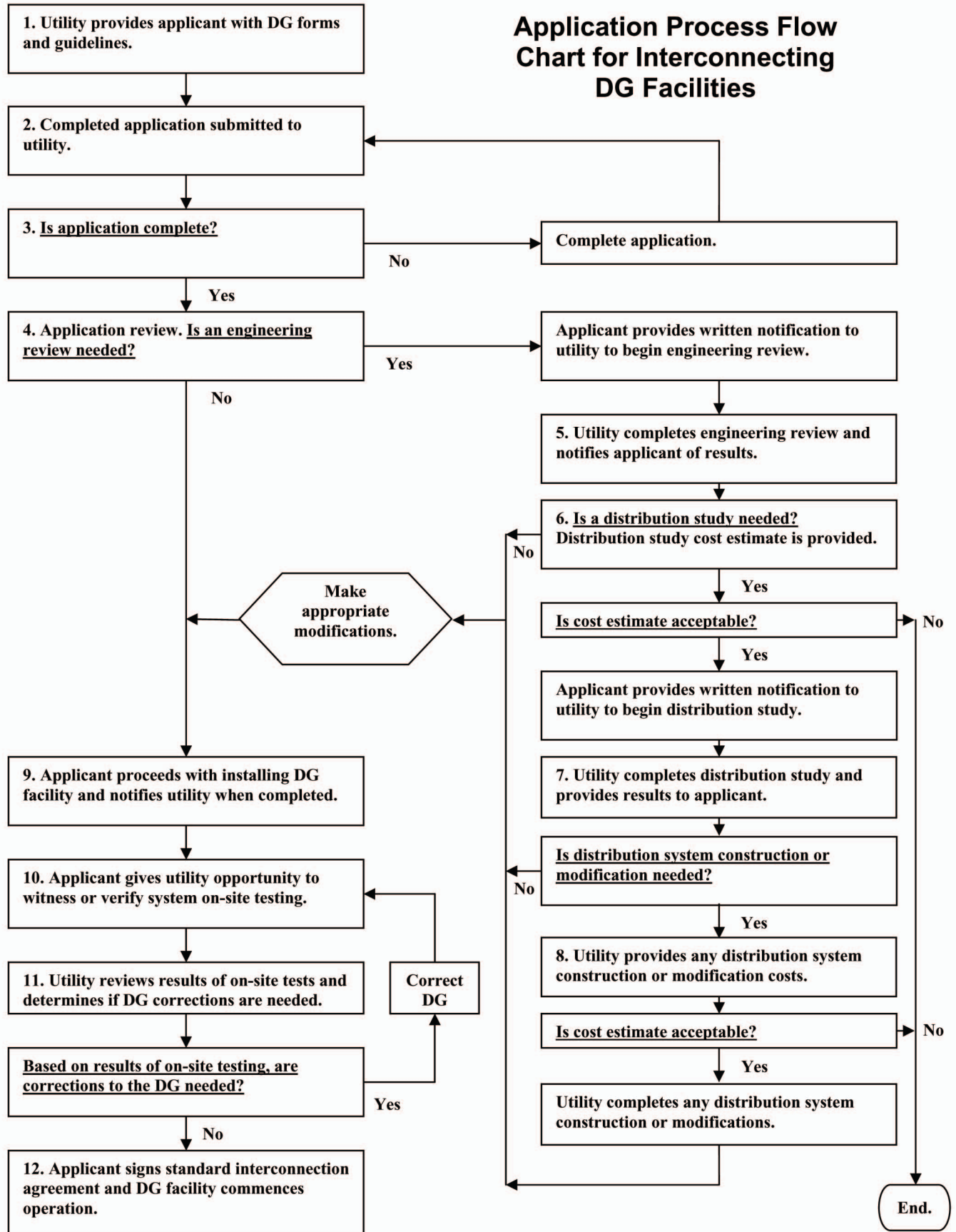



Clark Electric Cooperative

Greenwood, WI

DG Application Form

Your Touchstone Energy® Partner



Standard Distributed Generation Application Form (Generation 20 kW or less)

Distributed By

Name & Address

Supplied By

Name & Address

Clark Electric Cooperative
124 N. Main St. P. O. Box 190
Greenwood, WI 54437-0190

1. Contact Information -- The applicant is the party that is legally responsible for the generating system

Applicant's Last First Middle

Applicant's Mailing Address

Applicant's Phone Number E-mail Address

Emergency Contact Numbers

Responsible Party's Day Phone Responsible Party's Evening Phone Responsible Party's Weekend Phone

2. Location of the Generation System

Street Address

Latitude - Longitude: (i.e. 49° 32' 06" N -- 91° 64' 18" W) -- optional County

3. Electric Service Account Number

4. Applicant's Ownership Interest in the Generation System

Owner Co-owner Lease Other: _____

5. Primary Intent of the Generation System

- Onsite use of power, or net energy billing Commercial power sales to a third party

Page 2 -- Standard Distributed Generation Application Form (Generation 20 kW or less)

6. Electricity Use, Production and Purchases

- (a) Anticipated annual electricity consumption of the facility or site: _____ (kWh)/yr.
- (b) Anticipated annual electricity production of the generation system: _____ (kWh)/yr.
- (c) Anticipated annual electricity purchases (i.e., (a) minus (b)) _____ (kWh)/yr. *

* Value will be negative if there are net sales to the The Cooperative.

7. Installing Contractor Information

Contractor's Last Name _____ First Name _____ Middle Initial _____

Name of Firm _____

Contractor's Phone Number

E-mail Address

(____) ____ - ____

Mailing Address

8. Requested In-Service Date

9. Provide One-Line Schematic Diagram of the System:

Schematic is Attached

Number of pages

10. Generator/Inverter Information

Manufacturer

Model No.

Version No.

Serial No.

Generation Type (check one)

Generation Type (check one)

- Single Phase Three Phase Synchronous Induction Inverter Other: _____

Name Plate AC Ratings (check one)

- _____ kW _____ kVA _____ volts

Primary Energy Source

Note: If there is more than one generator and/or inverter, attach an additional sheet describing each.

11. Site Plan Showing Location of the External Disconnect Switch (attach additional sheets as needed)

12. Liability Insurance

| | |
|--|--|
| Carrier | Limits: |
| <input style="width: 95%;" type="text"/> | <input style="width: 95%;" type="text"/> |
| Agent Name | Phone Number |
| <input style="width: 95%;" type="text"/> | <input style="width: 95%; text-align: center;" type="text" value="(___) ___ - ___"/> |

The Applicant, (Site Owner or Operator, if different) shall provide a Certificate of Insurance, both demonstrating that this liability insurance is in place.

13. Design Requirements

- (a) Has the proposed distributed generation paralleling equipment been certified? Y N
- (b) If not certified, does the proposed distributed generator meet the operating limits defined Y N
Wis. Admin. Code chapter PSC 119?

For items 13(a) and 13(b), if your answer is yes, please furnish details (e.g., copies of manufacturer's specifications).
If you do not know the answer, it is recommended you contact the equipment manufacturer for the answer
and provide the same with the completed application.

14. Other Comments, Specification and Exceptions (attach additional sheets if needed)

15. Applicant and Installer Signature

To the best of my knowledge, all the information provided in this Application Form is complete and correct.

| | |
|--|--|
| Applicant Signature | Date |
| <input style="width: 95%;" type="text"/> | <input style="width: 95%;" type="text"/> |
| Installer Signature | Date |
| <input style="width: 95%;" type="text"/> | <input style="width: 95%;" type="text"/> |



Clark Electric Cooperative

Greenwood, WI

DG Interconnection Agreement

Your Touchstone Energy® Partner



Distributed Generation Interconnection Agreement (20 kW or less)

Distributed By

Name & Address

Supplied By

Name & Address

Applicant represents and warrants that:

This Distributed Generation Interconnection Agreement (the "Agreement"), is made and entered

into this _____ (day) of _____ (month), _____ (year) by and between

_____ hereinafter called "The Cooperative" and _____

hereinafter called the "Applicant." The Cooperative and the Applicant are hereinafter collectively referred to as the "Parties" and individually as a "Party."

Recitals

- A. The Cooperative is the owner of the electric distribution system serving _____ [Insert legal description of property or address] ("The Cooperative's Distribution System").
- B. Applicant desires to install a Distributed Generation (DG) facility or energy storage device with a capacity up to 20 kW, including related interconnection equipment (the "DG Facility") and to interconnect the DG Facility to The Cooperative's Distribution System.
- C. The Cooperative has previously reviewed and approved Applicant's DG Interconnection Application Form, dated _____, and supporting materials (the "Application"). The completed Application is attached as Exhibit 1 and incorporated into this Agreement.
- D. Applicant wishes to interconnect the DG Facility to The Cooperative's Distribution System and The Cooperative is willing to permit such interconnection subject to the terms and conditions set forth in: (1) Wisconsin Administrative Code Chapter PSC 119; (2) the completed Application approved by the Cooperative; and (3) this Agreement. No agency or partnership is created with the interconnection of the applicant's DG Facility.

Agreement

NOW THEREFORE, in consideration of the foregoing Recitals and for good and valuable consideration, The Cooperative and Applicant agree as follows:

1. Design Requirements.

The DG Facility shall be installed in compliance with Wisconsin Administrative Code Chapter PSC 119.

2. Applicant's Representations and Warranties.

- a. the DG Facility is fully and accurately described in the Application;
- b. all information in the Application is true and correct;
- c. the DG Facility has been installed to Applicant's satisfaction;
- d. Applicant has been given warranty information and an operation manual for the DG Facility; and
- e. Applicant has been adequately instructed in the operation and maintenance of the DG Facility.

3. Interconnection Disconnect Switch.

The Cooperative will require that the Applicant furnish and install an interconnection disconnect switch that opens, with a visual break, all ungrounded poles of the interconnection circuit. The interconnection disconnect switch shall be rated for the voltage and fault current requirements of the DG Facility, and shall meet all applicable UL, ANSI, and IEEE standards, as well as applicable requirements of the Wisconsin State Electrical Code, Volume 2, Wis. Adm. Code Chapter Comm 16. The switch enclosure shall be properly grounded. The interconnection disconnect switch shall be accessible at all times, located for ease of access to Public Utility personnel, and shall be capable of being locked in the open position. The Applicant shall follow The Cooperative's recommended switching, clearance, tagging, and locking procedures.

4. Modifications to the DG Facility.

Applicant shall notify The Cooperative of plans for any material modification to the DG Facility by providing at least twenty (20) working days advance notice. A "material modification" is defined as any modification that changes the maximum electrical output of the DG Facility or changes the interconnection equipment (e.g., changing from certified to non-certified devices or replacement of any component with a component of different functionality or UL listing). The notification shall consist of a completed, revised Application and such supporting materials as may be reasonably requested by The Cooperative. Applicant agrees not to commence installation of any material modification to the DG Facility until The Cooperative has approved the revised Application. The Cooperative shall indicate its written approval or rejection of any revised Application within twenty (20) working days after it receives the completed application and all supporting materials.

5. Insurance.

Throughout the term of this Agreement, Applicant shall carry the following insurance:

A liability insurance policy that provides protection against claims for damages resulting from (i) bodily injury, including wrongful death; and (ii) property damage arising out of Applicant's ownership and/or operation of the DG Facility under this Agreement. The limits of such policy shall be at least \$300,000 per occurrence or prove financial responsibility by another method acceptable, and approved in writing, to The Cooperative. The failure of the Applicant or The Cooperative to enforce the minimum levels of insurance does not relieve the Applicant from maintaining such levels of insurance or relieve Applicant of any liability. Prior to execution of this Agreement applicant shall provide The Cooperative with a certificate of insurance containing a minimum 30-day notice of cancellation.

6. Indemnification.

Subject to the limitations set forth in this Section, and to the extent allowable by law, each Party to this Agreement shall indemnify, hold harmless and defend the other Party, its officers, directors, employees and agents from and against any and all claims, suits, liabilities, damages, costs and expenses (including without limitation, reasonable attorneys and expert witness fees) for damage to property, or injury to, or death of, any individual, including the employees, officers, directors and agents of the indemnified Party or any other third parties, to the extent caused wholly or in part by the negligence or the intentional wrongdoing of the indemnifying Party. Notwithstanding anything in this Section or in any other provision of this Agreement to the contrary, the liability of each Party to this Agreement shall be limited to direct actual damages, and all other damages at law or in equity are hereby waived. Under no circumstances shall a Party be liable to the other Party, whether in tort, contract or other basis in law or equity for any special, indirect, punitive, exemplary, or consequential damages, including lost profits. Applicant's and The Cooperative's indemnification obligations under this Section and the limits upon their respective liability shall continue in full force and effect notwithstanding the expiration or termination of this Agreement with respect to any event or condition giving rise to an indemnification obligation that occurred prior to such expiration or termination.

7. DG Facility Commissioning Testing.

Applicant shall notify The Cooperative in writing that installation of the DG Facility is complete and that the interconnection equipment is available for testing by The Cooperative at least fifteen (15) working days before Applicant interconnects the DG Facility with The Cooperative's Distribution System. The Cooperative shall thereupon have the right to test the DG Facility. The Cooperative shall also have the right to witness any testing by Applicant of the DG Facility. Any Cooperative testing of the DG Facility shall be completed within ten (10) working days. If The Cooperative waives its right to test the installed DG Facility by notifying Applicant in accordance with this Section, Applicant may interconnect the DG Facility to The Cooperative's Distribution System upon the earlier to occur of the following: (a) notification by The Cooperative; or (b) fifteen (15) working days after Applicant has notified The Cooperative that installation of the DG Facility is complete.

8. Access to DG Facility.

Applicant shall permit (and, if the land on which the DG Facility is located is not owned by Applicant, cause such land owner to permit) The Cooperative's employees and agents to enter the property on which the DG Facility is located at any reasonable time for the purposes of inspecting and/or testing Applicant's DG Facility to insure its continued safe and satisfactory operation and the accuracy of The Cooperative's meters. Such inspections shall not relieve Applicant from its obligation to maintain the DG Facility and any related equipment owned by Applicant in safe and satisfactory operating condition.

The Cooperative shall have the right to witness any testing by Applicant of the DG Facility.

9. Disconnection of a DG Facility to Permit Maintenance and Repairs.

Upon reasonable notice by The Cooperative, Applicant shall disconnect the DG Facility to permit The Cooperative to perform routine repairs and maintenance to The Cooperative's Distribution System, or to install modifications thereto.

10. Disconnection of a DG Facility without Notice.

When The Cooperative so requests, Applicant shall discontinue operation of the DG Facility and The Cooperative may isolate the DG Facility from The Cooperative's Distribution System, upon any of the following:

- a. Termination of this Agreement;
- b. If, in The Cooperative's reasonable judgment, the DG Facility fails to comply with the Design Requirements specified in Wisconsin Administrative Code §§ PSC 119.20 and PSC 119.25.
- c. In the event of an emergency on The Cooperative's Distribution System; or
- d. Upon any other breach of this Agreement by Applicant (a "Default"), that Applicant fails to remedy within ten (10) working days after receipt of written notice from The Cooperative.

In the event of such disconnection, pursuant to b, c, or d above, the DG Facility shall remain isolated from The Cooperative's Distribution System until, in the reasonable judgment of The Cooperative, the DG Facility meets the Design Requirements, Applicant has cured any Default, and The Cooperative's Distribution System is functioning in a safe manner. If Applicant fails to cure a Default within sixty (60) working days, The Cooperative shall further have the right to terminate this Agreement without liability to Applicant for such termination.

11. Disputes; Right to Appeal.

Wisconsin Administrative Code §PSC 119.40 does not apply to this agreement. Applicant may file a request with the Clark Electric Cooperative Board of Directors to appeal any requirement imposed by Clark Electric as a condition to interconnection of DG Facility, that Applicant alleges is unreasonable

12. Amendments; Non-Waiver.

Any amendment or modification to this Agreement must be in writing and executed by Applicant and The Cooperative. The failure of Applicant or The Cooperative to insist on performance by the other Party of any provision of this Agreement shall not waive the right of the Party who failed to insist on performance to enforce the same provision at a later time.

13. Term of Agreement.

This Agreement shall become effective immediately upon the execution, by the Parties, and shall continue in effect until terminated by any of the following:

- a. Mutual written agreement of the Parties;
- b. Abandonment or removal of the DG Facility by Applicant;
- c. By The Cooperative pursuant to Section 10 of this Agreement;
- d. By Applicant upon thirty (30) working days prior written notice given to the The Cooperative.

14. Successors and Assigns.

- a. Assignment by Applicant. Applicant shall not assign its rights and obligations under this Agreement in whole or in part without the prior written consent of The Cooperative, which consent shall not be unreasonably withheld or unduly delayed. The Cooperative may withhold its consent to any proposed assignment if the proposed assignee fails to assume the obligations of Applicant under this Agreement in writing.
- b. Assignment by The Cooperative. The Cooperative shall have the right to assign this Agreement in whole upon written notification to the Applicant.
- c. Successors. This Agreement shall be binding upon the personal representatives, heirs, successors, and permitted assigns of the respective Parties.

15. Applicant and Cooperative Signature.

IN WITNESS WHEREOF, Applicant and The Cooperative have executed this Agreement as of the year and date first set forth above.

Applicant Signature

Title

Date

The Cooperative

Signature / Title

Date

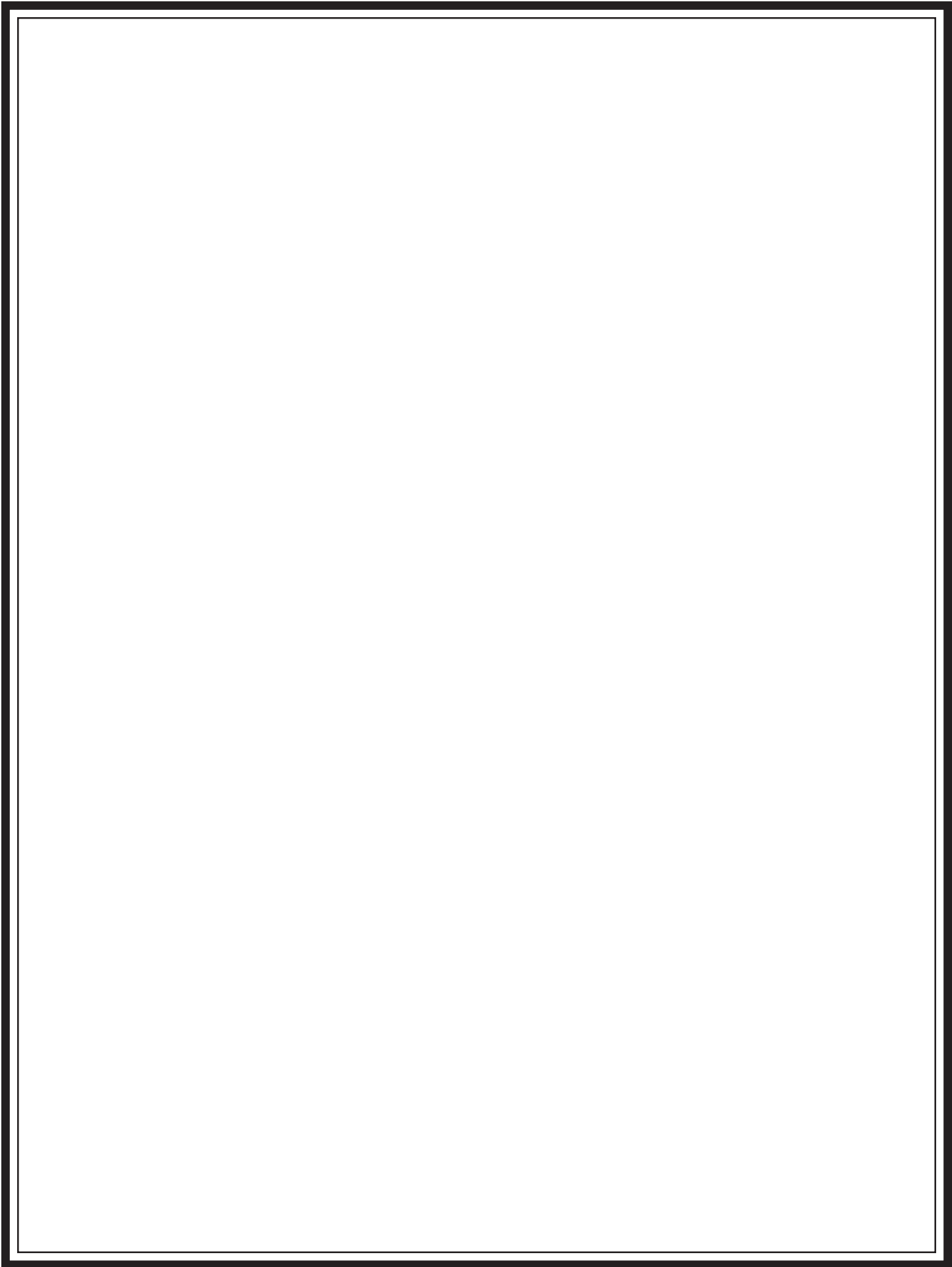



Clark Electric Cooperative

Greenwood, WI

**Wisconsin DG
Interconnection Guidelines**

Your Touchstone Energy® Partner



Wisconsin Distributed Generation Interconnection Guidelines

Version Date: 4-9-04

Referenced to PSC 119

NOTICE: These guidelines were prepared by the Wisconsin Interconnection Collaborative. Material in these guidelines does not imply a recommendation or endorsement of any product or service by the Wisconsin Interconnection Collaborative, or any participant of the Wisconsin Interconnection Collaborative. The Wisconsin Interconnection Collaborative, or any participant of the Wisconsin Interconnection Collaborative makes no warranty, express or implied, and does not assume legal liability or responsibility for the accuracy, completeness, or usefulness of any information, apparatus, product, or process disclosed, and does not represent that its use would not infringe privately owned rights.

Wisconsin Distributed Generation Interconnection Guidelines

| | |
|---|----|
| 1.0 OVERVIEW..... | 4 |
| 2.0 GENERAL REQUIREMENTS | |
| Applicant Responsibilities..... | 6 |
| Designated Point of Contact..... | 6 |
| Definition of DG Facility Size Categories..... | 6 |
| Application Process for Interconnecting DG Facilities..... | 6 |
| Application Process Flow Chart for Interconnecting DG Facilities..... | 9 |
| Agreements..... | 10 |
| Insurance..... | 10 |
| Modifications to DG Facilities..... | 11 |
| Fees and Distribution System Costs..... | 11 |
| Easements and Rights-of-Way..... | 12 |
| Disconnection..... | 12 |
| DG Facility Operations Manual..... | 12 |
| DG Facility Maintenance Records..... | 12 |
| Interconnection to a Transmission System..... | 12 |
| One-line Schematic Diagram..... | 13 |
| Control Schematics..... | 13 |
| Site Plan..... | 13 |
| Procedure for Appealing to the Commission..... | 13 |
| 3.0 DESIGN REQUIREMENTS | |
| <u>General Design Requirements</u> | |
| General Design Requirements..... | 14 |
| DG Facility Equipment Protection..... | 14 |
| Equipment Circuit Breakers..... | 14 |
| Interconnection Disconnect Switch..... | 14 |
| Labeling Requirements..... | 15 |
| Revenue Metering Requirements..... | 15 |
| Grounding..... | 15 |
| Operating Limits..... | 15 |
| Power Factor..... | 15 |
| Power Quality..... | 15 |
| Synchronizing DG Facilities..... | 16 |
| Automatic Interrupting Device..... | 16 |
| Minimum Protection Function Requirements for Non-Certified DG Facilities..... | 16 |
| Test Switches..... | 17 |
| Dedicated Transformer..... | 17 |
| Spot Networks..... | 17 |
| Telemetry / SCADA..... | 17 |
| 4.0 EQUIPMENT CERTIFICATION | |
| Certified Paralleling Equipment..... | 18 |
| Non-Certified Paralleling Equipment..... | 18 |
| 5.0 COMMISSIONING TESTS | |
| Anti-islanding Test..... | 19 |
| Commissioning Tests for Paralleling Equipment in Categories 2 – 4..... | 19 |
| Additional Tests..... | 19 |

APPENDIX LIST

| | | |
|--------------|--|----|
| Appendix I | Glossary..... | 20 |
| Appendix II | Protection System Functions..... | 23 |
| Appendix III | Operating Limits, Power Quality, and Standards Summary..... | 26 |
| Appendix IV | Codes and Standards..... | 28 |
| Appendix V | Sample One-Line Diagram (Category 1: 20 kW or less)..... | 30 |
| Appendix VI | Sample One-Line Diagram (Categories 2-4: Greater than 20 kW to 15 MW)... | 31 |

1.0 OVERVIEW

The “Wisconsin Distributed Generation Interconnection Guidelines” was developed in response to §196.496, Wisconsin Statutes relating to the development of rules for the interconnection of distributed generation (DG) to Wisconsin electric providers. Wisconsin’s cooperative electric utilities are not subject to Statute §196.496, or the interconnection rules. However cooperative electric utilities are encouraged to adopt the guidelines.

Section 196.496 of the statutes was created by Wisconsin Act 16 to read:

§196.496 Distributed generation facilities. (1) DEFINITION. In this section, “distributed generation facility” means a facility for the generation of electricity with a capacity of no more than 15 megawatts that is located near the point where the electricity will be used or is in a location that will support the functioning of the electric power distribution grid.

(2) RULES. The commission shall promulgate rules establishing standards for the connection of distributed generation facilities to electric distribution facilities. To the extent technically feasible and cost effective, the standards shall be uniform and shall promote the development of distributed generation facilities. The standards shall address engineering, electric reliability, and safety concerns and the methods for determining charges for interconnection.”

The non-statutory provisions of 2001 Wisconsin Act 16 is as follows:

DISTRIBUTED GENERATION RULES.

(a) The public service commission shall submit in proposed form the rules required under section §196.496 (2) of the statutes, as created by this act, to the legislative council staff under section §227.15 (1) of the statutes.

(b) The public service commission shall create a committee under section §227.13 of the statutes to advise the commission with respect to promulgating the rules required under section §196.496 (2) of the statutes, as created by this act. The advisory committee shall consist of one employee each of the department of administration and the department of natural resources, designated by the secretaries of the respective departments, and members who represent interests regarding DG facilities, including DG equipment manufacturers and installers, customers, energy advocacy groups, electric provider workers, environmental groups, public utilities, and electric cooperative associations.”

The major objective of this document is to provide guidance about the requirements for interconnecting a DG facility to the distribution system. The guidelines are intended for retail electric customers, independent power producers (IPPs), independently owned generators or any other parties interested in operating a DG facility, 15 MW or less, in parallel with an electric distribution system in Wisconsin.

This document provides guidance in applying the rules codified by Chapter 119 of the Wisconsin Administrative Code. The Chapter 119 rules define an application process, an application form, an interconnection agreement, requirements for grounding, metering, use of certified or non certified equipment, safety equipment, power quality and testing, and compliance with applicable national, state, and local codes. The key elements of the guidelines are contained in Sections 2 and 3, which describe the application process and technical

requirements for interconnecting DG facilities to the distribution system. A detailed common set of definitions is provided in the Glossary (**Appendix I**).

Although this document addresses requirements for all sizes of generation up to 15 MW, the application process and requirements are streamlined for DG facilities that have a capacity of less than 20 kW.

A standard application form must supply sufficient information to allow an electric provider to accurately evaluate the interconnection requirements¹ for a DG facility, but not so burdensome as to become a barrier. The standard application form has been designed to make clear what information is required for the application to be processed efficiently. Comprehensive and user-friendly standard application forms are appended to the guidelines

Issues not addressed in the guidelines include, but are not limited to, environmental permitting, municipal ordinances, relevant tariffs, stranded cost recovery mechanisms, and economic/system benefits.

The guidelines will apply to all DG facilities, not owned by a public utility, that intend to operate in parallel with the distribution system and are subject to the jurisdiction of the commission. Any non-public utility that seeks voluntary compliance may adopt these procedures and agreements.

Indemnity, liability, insurance coverage and other business matters are set forth in the standard interconnection agreements.

These standard interconnection requirements should, in general, only apply to units interconnected after the issuance of a commission opinion and order for PSC 119: Rules for the Interconnecting Distributed Generation Facilities. In most cases, the standard interconnection requirements should not force retrofits on DG facility owners that have already complied with pre-existing electric provider and other code requirements. The only exceptions would be if the electric provider can demonstrate to the commission that the safety and reliability of the electric system would be threatened without a retrofit, or if the pre-existing tariff or agreement underlying the approval to interconnect required upgrades upon a change in technical standards.

¹ As expressed in this document.

2.0 GENERAL REQUIREMENTS

Applicant Responsibilities

An applicant shall be responsible for and will coordinate the design, installation, operation, and maintenance of its DG facilities to conformance with the requirements of Wisconsin Administrative Code - Chapter 119, relevant laws, applicable codes and regulations (local, state, and federal). The requirements specified in the guidelines are designed to protect distribution system facilities, avoid electrical interference problems, ensure the safety of customers, electric provider employees, and the general public, and maintain overall system reliability. The responsibility of protecting DG Facilities is the applicant's and should be accomplished through the proper installation, operation, and maintenance of the specified protective devices. The applicant shall obtain, at its expense, any and all authorizations, permits and licenses required for the construction and operation of its DG Facilities.

Designated Point of Contact [ref. PSC 119.03]

Each electric provider shall designate one point of contact for all customer inquiries related to DG facilities and from which interested parties can obtain interconnection guidelines and the appropriate standard commission application and interconnection agreement forms. Each electric provider shall have current information concerning its DG point of contact on file with the commission.

Definition of DG Facility Categories [ref. PSC 119.02]

Size categories are listed according to nameplate ratings for each connection to the electric provider's distribution system. Applicants must satisfy the general and technical requirements provided in this document for each DG facility category.

| Category | DG Facilities |
|------------|---|
| Category 1 | 20 kW or less |
| Category 2 | Greater than 20 kW and not more than 200 kW |
| Category 3 | Greater than 200 kW and not more than 1 MW |
| Category 4 | Greater than 1 MW and not more than 15 MW |

Application Process for Interconnecting DG Facilities [ref. PSC 119.04]

The application process steps for all categories of DG facilities are listed below. *Standard Application Forms for interconnection; PSC Form 6027 (for Category 1: 20 kW or less) OR PSC 6028 (for Categories 2 – 4: greater than 20 kW to 15 MW); shall be used for interconnecting DG Facilities.*

STEP 1 – The electric provider shall respond to each request for DG interconnection by furnishing, within 5 working days, its guidelines and the appropriate standard application form.

STEP 2 – The applicant shall complete and submit the standard application form to its public utility.

STEP 3 – Within 10 working days of receiving a new or revised application, the public utility shall notify the applicant whether the application is complete.

STEP 4 – Within 10 working days of determining that the application is complete, the public utility shall complete its application review. If the public utility determines, on the basis of the application review that an engineering review is needed, it shall notify the applicant and state the cost of that review. For Categories 2 and 3, the cost estimate shall be valid for one year. For Category 4, the time period shall be negotiated but may not exceed one year. If the

application review shows that an engineering review is not needed, the applicant may install the DG facility and need not complete the steps described in steps 5 to 9.

STEP 5 – If the public utility determines on the basis of the application review that an engineering review is needed, upon receiving from the applicant written notification to proceed and receipt of applicable payment from the applicant, the public utility shall complete an engineering review and notify the applicant of the results within the following times:

- (a) Category 1 DG application, 10 working days.
- (b) Category 2 DG application, 15 working days.
- (c) Category 3 DG application, 20 working days.
- (d) Category 4 DG application, 40 working days.

NOTE: An expedited engineering review may be available at an additional expense to the applicant.

STEP 6 – If the engineering review indicates that a distribution system study is necessary, the public utility shall include, in writing, a cost estimate in its engineering review. The cost estimate shall be valid for one year and the applicant shall have one year from receipt of the cost estimate in which to notify the public utility to proceed, except for a Category 4 DG application, in which case the time period shall be negotiated, but may not extend beyond one year. Upon receiving written notification to proceed and payment of the applicable fee, the public utility shall conduct the distribution system study.

STEP 7 – The public utility shall within the following time periods complete the distribution system study and provide study results to the applicant:

- (a) Category 1 DG application, 10 working days.
- (b) Category 2 DG application, 15 working days.
- (c) Category 3 DG application, 20 working days.
- (d) Category 4 DG application, 60 working days unless a different time period is mutually agreed upon.

NOTE: An expedited distribution system study may be available at an additional expense to the applicant.

STEP 8 - The public utility shall perform a distribution system study of the local distribution system and notify the applicant of findings along with any distribution system construction or modification costs to be borne by the applicant.

STEP 9 - If the applicant agrees, in writing, to pay for any required distribution system construction and modifications, the public utility shall complete the distribution system upgrades and the applicant shall install the DG facility within a time frame that is mutually agreed upon. The applicant shall notify the public utility when project construction is complete.

STEP 10 - (a) The applicant shall give the public utility the opportunity to witness or verify the system testing, as required in s. PSC 119.30 or PSC 119.31. Upon receiving notification that an installation is complete, the public utility has 10 working days, for a Category 1 or 2 DG project, or 20 working days, for a Category 3 or 4 DG project, to complete the following:

- 1. Witness commissioning tests.
- 2. Perform an anti-islanding test or verify the protective equipment settings at its expense.
- 3. Waive its right, in writing, to witness or verify the commissioning tests.

(b) The applicant shall provide the public utility with the results of any required tests.

STEP 11 – The public utility may review the results of the on-site tests and shall notify the applicant within 5 working days, for a Category 1 DG project, or within 10 working days, for a Category 2 to 4 DG project, of its approval or disapproval of the interconnection. If approved, the public utility shall provide a written statement of final acceptance and cost reconciliation. Any applicant for a DG system that passes the commissioning test may sign a standard interconnection agreement and interconnect. If the public utility does not approve the interconnection, the applicant may take corrective action and request the public utility to reexamine its interconnection request.

STEP 12 - A standard interconnection agreement shall be signed by the applicant and public utility before parallel operation commences.

Application Process Flow Chart for Interconnecting DG Facilities

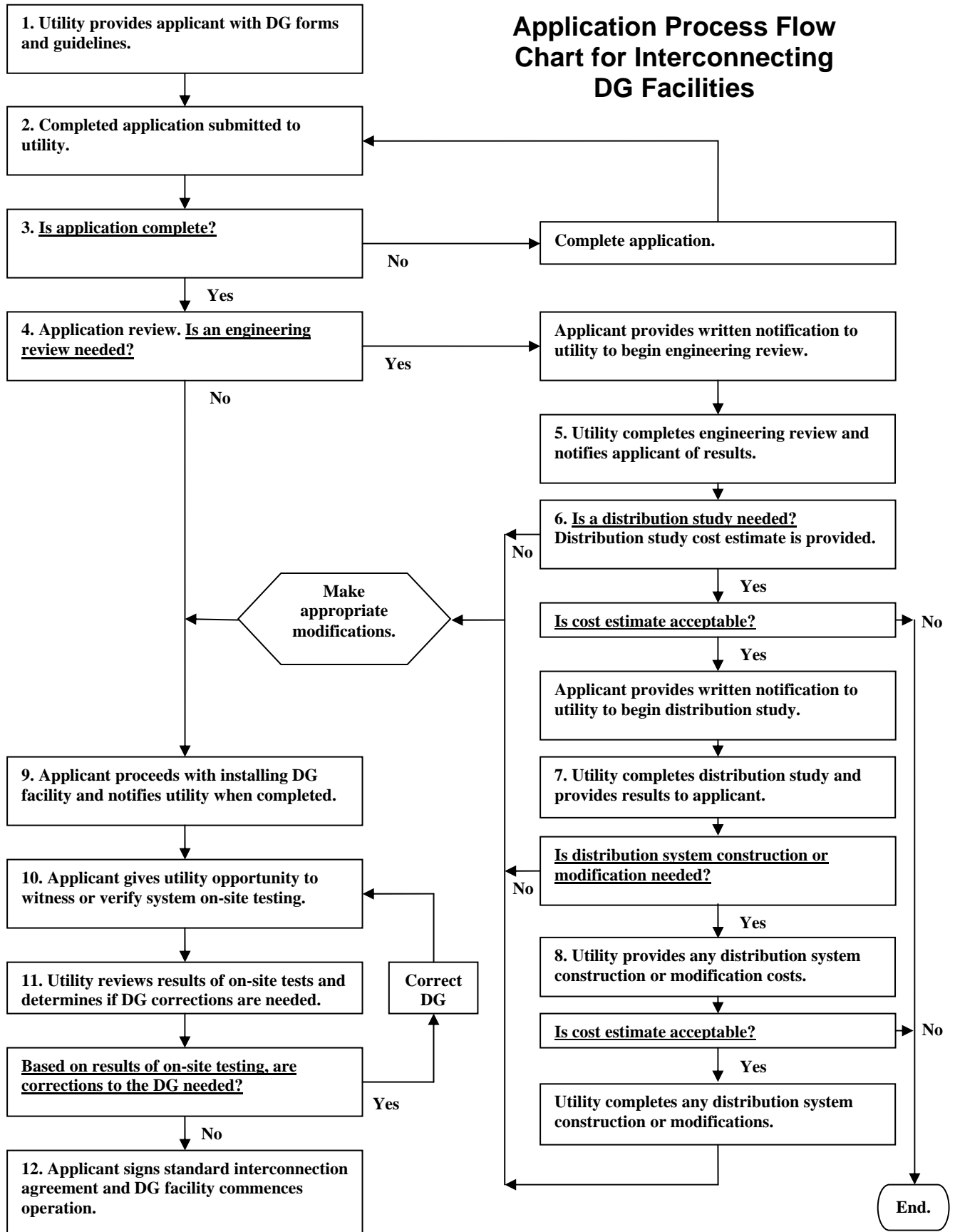

Agreements

A DG facility applicant must have all necessary agreements executed before parallel operation commences.

The agreements DG facilities will need to complete include:

- A standard interconnection agreement [**PSC Form 6029** (for Category 1: 20 kW or less) OR **PSC Form 6030** (for Categories 2 – 4: greater than 20 kW to 15 MW)] shall be signed by the applicant and electric provider before parallel operation can commence.
- Either retail rate tariff (typically category 1 DG facility) or purchase power agreement (typically DG facility categories 2, 3, and 4).

The agreements DG facilities may need to complete include:

- Wheeling agreement (typically DG facility categories 2, 3, and 4).
- Back up power agreements.
- Where an electric provider line extension is required to accommodate the interconnection, the applicant shall provide, or obtain from others and provide, suitable easements or rights of way - at the expense of the applicant.

DG facilities that are selling the output of the generator to a third party entity (e.g., IPPs) shall be required to have a standard interconnection agreement with the electric provider and must comply with other requirements of FERC, MISO, and state laws & regulations.

Applicants must sign a power purchase agreement/tariff with their electric provider for export of power over the distribution system. The applicant will be required to:

- a) Negotiate for the sale of electricity with the purchaser of the electric power (subject to nondisclosure provisions of the commission).
- b) Sign a power purchase agreement with the purchaser of the electric power.
- c) Sign a wheeling contract with the electricity provider, when selling to a third party.
- d) For non-net energy billed customers, a backup power agreement must be signed for any power required from the electric provider's distribution system.

All tariffs under a power purchase/supply agreement and backup power agreement are subject to change by the electric provider and approval by the commission or appropriate regulatory body.

Insurance [ref. PSC 119.05]

(1) An applicant seeking to interconnect a DG facility to the distribution system of a public utility shall maintain liability insurance equal to or greater than the amounts stipulated in the following table, per occurrence, or prove financial responsibility by another means mutually agreeable to the applicant and the public utility. For a DG facility in Categories 2 to 4, the applicant shall name the public utility as an additional insured party in the liability insurance policy.

| Category | Generation Capacity | Minimum Liability Insurance Coverage Required |
|----------|------------------------------|---|
| 1 | 20 kW or less | \$ 300,000 |
| 2 | Greater than 20 kW to 200 kW | \$ 1,000,000 |
| 3 | Greater than 200 kW to 1 MW | \$ 2,000,000 |
| 4 | Greater than 1 MW to 15 MW | Negotiated |

(2) Each party to the standard interconnection agreement shall indemnify, hold harmless and defend the other party, its officers, directors, employees and agents from and against any and all claims, suits, liabilities, damages, costs and expenses resulting from the installation, operation, modification, maintenance or removal of the DG facility. The liability of each party

shall be limited to direct actual damages, and all other damages at law or in equity shall be waived.

NOTE: DG facilities interconnected to the transmission network are required by the American Transmission Company to maintain liability insurance of \$25 million per interconnection.

Modifications to DG Facilities [ref. PSC 119.06]

The applicant shall notify the public utility of plans for any material modification to the DG facility by providing at least 20 working days of advance notice for a Category 1 DG facility, 40 working days for Category 2 DG facility, and 60 working days for a Category 3 or 4 DG facility. The applicant shall provide this notification by submitting a revised standard application form and such supporting materials as may be reasonably requested by the public utility. The applicant may not commence any material modification to the DG facility until the public utility has approved the revised application, including any necessary engineering review or distribution system study. The public utility shall indicate its written approval or rejection of a revised application within the number of working days shown in the table below. Upon completion of the application process, a new standard interconnection agreement shall be signed by both parties prior to parallel operation. If the public utility fails to respond in the time specified in the following table, the completed application is deemed approved.

| Category | Generation Capacity After Modification | Working Days for Utility's Response to Proposed Modifications |
|----------|--|---|
| 1 | 20 kW or less | 20 |
| 2 | Greater than 20 kW to 200 kW | 40 |
| 3 | Greater than 200 kW to 1 MW | 60 |
| 4 | Greater than 1 MW to 15 MW | 60 |

Fees and Distribution System Costs [ref. PSC 119.08]

(1) Upon receiving a standard application form, the public utility shall specify the amount of any engineering review or distribution system study fees. Application fees shall be credited toward the cost of any engineering review or distribution system study. The applicant shall pay the fees specified in the following table, unless the public utility chooses to waive the fees in whole or in part.

| Category | Generation Capacity | Application Review Fee | Engineering Review Fee | Distribution System Study Fee |
|----------|------------------------------|------------------------|------------------------|-------------------------------|
| 1 | 20 kW or less | None | None | None |
| 2 | Greater than 20 kW to 200 kW | \$250 | Max. \$500 | Max. \$500 |
| 3 | Greater than 200 kW to 1 MW | \$500 | Cost based | Cost based |
| 4 | Greater than 1 MW to 15 MW | \$1000 | Cost based | Cost based |

(2) The public utility may recover from the applicant an amount up to the actual cost, for labor and parts, of any distribution system upgrades required. No public utility may charge a commissioning test fee for initial start-up of the DG facility. The utility may charge for retesting an installation that does not conform to the requirements set forth in this chapter.

(3) Costs for any necessary line extension shall be assessed pursuant to s. PSC 113.1005.

NOTE: Typically, no distribution system modifications are expected for DG facilities of 10 kW or less. Any required distribution system upgrades shall be cost-based and borne by the applicant.

Easements and Rights-of-Way [ref. PSC 119.07]

If a public utility line extension is required to accommodate a DG interconnection, the applicant shall provide, or obtain from others, suitable easements or rights-of-way. The applicant is responsible for the cost of providing or obtaining these easements or rights of way.

Disconnection [ref. PSC 119.09]

A public utility may refuse to connect or may disconnect a DG facility from the distribution system only under any of the following conditions:

- (1) Lack of approved standard application form or standard interconnection agreement.
- (2) Termination of interconnection by mutual agreement.
- (3) Non-compliance with the technical or contractual requirements.
- (4) Distribution system emergency.
- (5) Routine maintenance, repairs, and modifications, but only for a reasonable length of time necessary to perform the required work and upon reasonable notice.

NOTE: The disconnection and reconnection conditions specified in PSC 113, Subchapter III also apply.

DG Facility Operations Manual

It is strongly recommended that parallel generation equipment be accompanied by an on-site copy of an operations manual that clearly outlines the start-up and shutdown procedures of the equipment, including operation of the disconnect switch, as well as any cautionary provisions.

DG Facility Maintenance Records

It is recommended that parallel generation equipment maintenance activities be noted and dated in a maintenance log kept near the unit.

Interconnection to a Transmission System

DG facilities, 1 MW or larger, may have an impact on the transmission system. The Midwest Independent System Operator (MISO) Generator Interconnection Procedures are vague in nature when referring to the connection of a generator to the local distribution system. If electricity from a DG facility is moved outside the local distribution system, the transmission system will be utilized. The interconnection of a 1 MW, or larger, DG facility may require upgrades to the transmission system. MISO may have to perform Interconnection studies - any study fees shall be paid by applicant. The applicant may also incur costs associated with transmission system modifications. Application review, engineering review, and distribution system study fees, listed in this document, do not include MISO's fees. The electric provider will facilitate completing the MISO application materials for the applicant. A transmission service request (TSR) may be required to move electricity on the transmission system.

Excerpt from MISO interconnection protocols:

A generator not intending to engage in the sale of wholesale energy, capacity, or ancillary services under the Midwest ISO Open Access Transmission Tariff (OATT), that proposes to interconnect a generating facility to the distribution system of a Transmission Owner or a local distribution utility interconnected with the Transmission System shall apply to the Transmission Owner or local distribution utility for interconnection. Where facilities under the control of the Midwest ISO are affected by such interconnections, such interconnections may be subject to the planning and operating protocols of the Midwest ISO and agreements applicable to the interconnection of the Transmission System with the distribution system of the Transmission Owner or local distribution utility.

Source: MISO FERC Electric Tariff, First Revised Volume No. 1, Original Sheet No. 237

One-line Schematic Diagram [ref. PSC 119.10]

(1) The applicant shall include a one-line schematic diagram with the completed standard application form (see examples in **Appendix V & VI**). ANSI symbols shall be used in the one-line schematic diagram to show the following:

- (a) Generator or inverter.
- (b) Point where the DG facility is electrically connected to the customer's electrical system.
- (c) Point of common coupling.
- (d) Lockable interconnection disconnect switch.
- (e) Method of grounding, including generator and transformer ground connections.
- (f) Protection functions and systems.

(2) The applicant shall include with the schematic diagram technical specifications of the point where the DG facility is electrically connected to the customer's electrical system, including all anti-islanding and power quality protective systems. The specifications regarding the anti-islanding protective systems shall describe all automatic features provided to disconnect the DG facility from the distribution system in case of loss of grid power, including the functions for over/under voltage, over/under frequency, overcurrent, and loss of synchronism. The applicant shall also provide technical specifications for the generator, lockable interconnection disconnect switch, and grounding and shall attach the technical specification sheets for any certified equipment. The applicant shall include with the schematic diagram a statement by the manufacturer that its equipment meets or exceeds the type tested requirements for certification.

Control Schematics [ref. PSC 119.11]

For equipment not certified under s. PSC 119.26, the applicant shall include with the application a complete set of control schematics showing all protective functions and controls for generator protection and distribution system protection.

Site Plan [ref. PSC 119.12]

For all categories, the applicant shall include with the application a site plan that shows the location of the interconnection disconnect switch, adjoining street name, and the street address of the DG facility. For Category 2, 3, or 4 DG facilities, the site plan shall show the location of major equipment, electric service entrance, electric meter, interconnection disconnect switch, and interface equipment.

Procedure for Appealing to the Commission [ref. PSC 119.40]

An aggrieved party can use the provisions of s. 119.4, Stats. to appeal an unfavorable decision by an electric utility.

PSC 119.40 Right to appeal. The owner of a generating facility interconnected or proposed to be interconnected with a utility system may appeal to the commission should any requirement of the utility service rules filed in accordance with the provisions of this chapter [PSC 119] be considered excessive or unreasonable. Such appeal will be reviewed and the customer notified of the commission's determination.

3.0 DESIGN REQUIREMENTS

General Design Requirements [ref. PSC 119.20 (1)]

Protection and safety devices are intended to provide protection for the distribution system, electric provider workers, electric provider customers and the general public. Protection devices will ensure that the fault current supplied by the DG facility is interrupted if a fault on the distribution system occurs. When a fault occurs and the electric provider's protective device operates, it will be necessary for the DG facility to be automatically disconnected from the distribution system. Since automatic reclosing is generally utilized on distribution systems to clear temporary faults, the applicant must insure that their DG facility is disconnected from the distribution system before the first automatic reclose occurs.

Islanding occurs when a DG facility becomes separated from the main generation source on a distribution system, but continues to independently serve a portion of the distribution system. DG facilities shall be equipped with protective hardware and/or software designed to prevent the generator from being connected to a de-energized distribution system. Islanding is not allowed under the terms of the guidelines.

The applicant shall install protection devices to ensure that the current supplied by the DG facility is interrupted if a fault or other potentially dangerous event occurs on the distribution system. If such an event occurs and the public utility's distribution system is de-energized, any DG facility that is connected to this distribution system shall automatically disconnect. All DG facilities shall utilize protection devices that prevent electrically closing a DG facility that is out of synchronization with the distribution system.

DG Facility Equipment Protection

The applicant will be responsible for protecting its DG facility equipment in such a manner that distribution system faults - such as outages, short circuits, automatic reclosing of distribution circuits, or other disturbances - do not damage the DG facility equipment. The equipment protection shall also prevent the DG facility from adversely affecting the distribution system's capability of providing reliable service to other customers.

Equipment Circuit Breakers [ref. PSC 119.20 (2)]

All installations shall include equipment circuit breakers, on the DG facility side of the point where the DG facility is electrically connected to the customer's electrical system, that are capable of interrupting the maximum available fault current. Equipment circuit breakers shall meet all applicable UL, ANSI, and IEEE standards.

NOTE: Equipment circuit breakers should not be confused with interconnection protection devices.

Interconnection Disconnect Switch [ref. PSC 119.20 (3)]

The public utility may require that the applicant furnish and install an interconnection disconnect switch that opens, with a visual break, all ungrounded poles of the interconnection circuit. The interconnection disconnect switch shall be rated for the voltage and fault current requirements of the DG facility, and shall meet all applicable UL, ANSI, and IEEE standards. The switch enclosure shall be properly grounded. The interconnection disconnect switch shall be accessible at all times, located for ease of access to public utility personnel, and shall be capable of being locked in the open position. The applicant shall follow the public utility's recommended switching, clearance, tagging, and locking procedures.

NOTE: Provisions of the Wisconsin Electrical Safety Code, Volume 2, ch. Comm 16 also apply to these installations.

Labeling Requirements [ref. PSC 119.20 (4)]

The applicant shall label the interconnection disconnect switch, “Interconnection Disconnect Switch”, by means of a permanently attached sign with clearly visible and permanent letters. The applicant shall provide and post its procedure for disconnecting the DG facility next to the switch.

Revenue Metering Requirements

The applicant shall provide, at a location approved by the electric provider, a suitable place for the metering equipment, operated and maintained by the electric provider and comply with the provisions of PSC 113.0817, Metering equipment records, and PSC 113.0926, Metering with one meter for net energy billing. It is in the best interest of the applicant to clarify electric provider metering requirements early in the design stage to avoid any delays.

Grounding [ref. PSC 119.20 (5)]

The applicant shall install an equipment grounding conductor, in addition to the ungrounded conductors, between the DG facility and the distribution system. The grounding conductors shall be available, permanent, and electrically continuous, shall be capable of safely carrying the maximum fault likely to be imposed on them by the systems to which they are connected, and shall have sufficiently low impedance to facilitate the operation of overcurrent protection devices under fault conditions. All DG transformations shall be multi-grounded. The DG facility may not be designed or implemented such that the earth becomes the sole fault current path.

NOTE 1: Grounding practices are also regulated by the Wisconsin Electrical Safety Code Volumes 1 and 2, as found in chs. Comm 16 and PSC 114.

NOTE 2: Grounding best practices can be found in IEEE Std 142-1991 (Green Book).

NOTE 3: It is strongly recommended that transient voltage surge suppression (TVSS) devices be utilized to protect the DG facility equipment.

Operating Limits [ref. PSC 119.20 (6)]

(1) Certified paralleling equipment shall conform to UL 1741 (January 17, 2001 Revision) or an equivalent standard as determined by the commission.

(2) Non-certified paralleling equipment shall conform to the requirements of IEEE 1547

NOTE 1: The UL standards are available at <http://ulstandardsinfontet.ul.com> and IEEE standards are available at <http://ieee.org> . They may also be viewed at the PSCW Library, 610 N. Whitney Way, Madison, WI.

NOTE 2: A synopsis of the operating limits can be found in **Appendix III**. The titles of the referenced standards can be found in **Appendix IV**.

Power Factor [ref. PSC 119.20 (7)]

(1) All Category 1 and 2 DG facilities shall be operated at a power factor greater than 0.9.

(2) All Category 3 and 4 DG facilities shall be operated at unity power factor or as mutually agreed between the public utility and applicant.

Power Quality [ref. PSC 119.20 (8)]

The DG facility shall not create system voltage or current disturbances that exceed the standards listed in ch. PSC 113, Subchapter VII.

When there is demonstrated, unreasonable interference to other customers and such

interference exceeds the system standards, the electric provider reserves the right, at its expense, to install special test equipment as may be required to perform a disturbance analysis and monitor the operation of the DG facility to evaluate the quality of power produced.

If the DG facility is demonstrated to be the source of the interference, and it is demonstrated that the interference produced exceeds electric provider's standards or, generally accepted industry standards, then the DG shall be disconnected and locked out from the distribution system. It shall be the responsibility of the customer to eliminate any interference problem caused by a DG facility.

The electric provider can provide the applicant with information available regarding the least cost method of eliminating the interference problem. Owners and operators of a DG facility should be aware of the power quality requirements in **Appendix III**.

Synchronizing DG Facilities [ref. PSC 119.20 (9)]

The applicant shall protect and synchronize its DG facility with the distribution system.

Automatic Interrupting Device [ref. PSC 119.20 (10)]

Each DG facility shall include an automatic interrupting device that is listed with a nationally recognized testing laboratory and is rated to interrupt available fault current. The interrupting device shall be tripped by any of the required protective functions.

Minimum Protection Requirements for Non-certified DG Facilities [ref. PSC 119.25]

(1) Each DG facility shall include protection and anti-islanding equipment to prevent the facility from adversely affecting the reliability or capability of the distribution system. The applicant shall contact the public utility to determine any specific protection requirements.

(2) The protective system functions, which may be met with microprocessor-based multifunction protection systems or discrete relays, are required. Protective relay activation shall not only alarm but shall also trip the generator breaker/contactors.

(3) In addition to anti-islanding protection, a DG facility shall meet the following minimum protection requirements:

(a) A Category 1 DG facility shall include:

1. Over/under frequency function.
2. Over/under voltage function.
3. Overcurrent function.
4. Ground fault protection.

(b) A Category 2, 3, or 4 DG facility shall include:

1. Over/under frequency function.
2. Over/under voltage function.
3. Overcurrent function.
4. Ground fault protection.
5. Synchronism check function.
6. Other equipment, such as other protective devices, supervisory control and alarms, telemetry and associated communications channel, that the public utility determines to be necessary. The public utility shall advise the applicant of any communications requirements after a preliminary review of the proposed installation.

NOTE 1: It is important that the applicant contact the electric provider at the earliest possible date, prior to the purchase of protection equipment, to determine any specific protection requirements.

NOTE 2: Protection functions are referenced in **Appendix II**.

(4) A DG facility certified pursuant to PSC 119.26 shall be deemed to meet the requirements of this section.

Test Switches [ref. PSC 119.20 (11)]

An applicant for interconnection of a Category 3 or Category 4 facility shall provide test switches as specified by the public utility, to allow for testing the operation of the protective functions without unwiring or disassembling the equipment.

Dedicated Transformer [ref. PSC 119.20 (12)]

The primary purpose of the dedicated transformer is to ensure that (a) the generator cannot become isolated at the secondary voltage level with a small amount of other-customer load, and (b) the generator does not contribute any significant fault current to other customers' electrical systems. A dedicated transformer may also assist in blocking any voltage fluctuation or harmonics produced by the DG facility. The electric provider will specify the transformer winding connections, basic insulation levels, lightning protection, any high side voltage taps and any grounding requirements based on the specific DG facility site location. The high side connection for four-wire distribution systems are normally grounded wye connections to assure a neutral conductor path for unbalanced currents.

The public utility may require a DG facility to be isolated from other customers by installation of a separate power transformer. When a separate transformer is required, the utility may include its actual cost in the distribution system upgrade costs. The applicant is responsible for supplying and paying for any custom transformer. This requirement does not apply to an induction-type generator with a capacity of 5 kW or less, or to other generating units of 10 kW or less that utilize a line-commutated inverter.

Spot Networks [ref. PSC 119.20 (13)]

Low voltage spot and grid networks systems have been designed to provide highly reliable power to specific, concentrated loads. Such systems are typically located in areas such as high load densities, such as downtown metropolitan areas and large customers. These systems contain two or more uniquely designed dedicated transformers that will operate with self contained "network protectors" and integrated controls. Because of the integrated aspects of this type of low voltage distribution subsystem design, the application of parallel generation into these subsystems is difficult, requiring detailed engineering analysis by both the electric provider and the distribution generation applicant. Without the installation of proper protective devices, the network can be stressed to the point of failure.

The owner of a DG facility designed to operate in parallel with a spot or secondary network service shall provide relaying or control equipment that is rated and listed for the application and is acceptable to the public utility.

Telemetry / SCADA [ref. PSC 119.20 (14)]

For a Category 3 or Category 4 DG facility, the public utility may require that the facility owner provide telemetry equipment whose monitoring functions include transfer-trip functionality, voltage, current, real power (watts), reactive power (vars), and breaker status.

4.0 EQUIPMENT CERTIFICATION

Some generation equipment, specifically its anti-islanding protection and power quality related distribution system interface, may already have been tested to a national standard(s) that addresses distribution system compatibility, electric shock hazard, and fire safety. Certified equipment does not require the design scrutiny, by the electric provider, that non-certified equipment typically requires. Certified interconnection equipment, as described below, shall not require testing within the interconnection equipment enclosure.

Certified Paralleling Equipment [ref. PSC 119.26]

DG paralleling equipment that a nationally recognized testing laboratory certifies as meeting the applicable type testing requirements of UL 1741 (January 17, 2001 revision) is acceptable for interconnection, without additional protection systems, to the distribution system. The applicant may use certified paralleling equipment for interconnection to a distribution system without further review or testing of the equipment design by the public utility, but the use of this paralleling equipment does not automatically qualify the applicant to be interconnected to the distribution system at any point in the distribution system. The public utility may still require an engineering review to determine the compatibility of the distributed generation system with the distribution system capabilities at the selected point of common coupling.

Non-Certified Paralleling Equipment [ref. PSC 119.27]

(1) Any DG facility that is not certified under s. PSC 119.26 shall be equipped with protective hardware or software to prevent islanding and to maintain power quality. The applicant shall provide the final design of this protective equipment. The public utility may review and approve the design, types of protective functions, and the implementation of the installation. The applicant shall own the protective equipment installed at its facility.

NOTE: It is strongly recommended that the applicant obtain written approval from the electric provider prior to ordering protective equipment.

(2) The applicant shall calibrate any protective system approved under sub.(1) to the specifications of the public utility. The applicant shall obtain prior written approval from the public utility for any revisions to specified protection system calibrations. The electric provider shall specify all calibrations for customer-owned protection systems that are required herein. The applicant must obtain prior written approval from the electric provider for any revisions to any specified protection system calibrations.

5.0 TESTING OF DG FACILITY INSTALLATIONS

Anti-islanding Test [ref. PSC 119.30]

The public utility may perform an anti-islanding test or observe the automatic shutdown before giving final written approval for interconnection of the DG facility. The anti-islanding test requires that the unit shut down upon sensing the loss of power on the distribution system. This can be simulated by either removing the customer meter or opening a disconnection switch while the generator is operating. Voltage across the customer side of the meter or disconnection switch shall be measured and must be observed to reduce to zero within two seconds after disconnection. The test shall be conducted with the generation as close to its full output as possible. If a voltage is sustained after the disconnection, approval of the installation shall not be given until corrective measures are taken with a subsequent successful shutdown test.

Commissioning Tests for Paralleling Equipment: Categories 2 - 4 [ref. PSC119.31]

The electric provider shall provide the acceptable range for interconnection protective equipment settings. The applicant shall program protective equipment settings into the protective equipment. The electric provider may verify, at its own cost, the protective equipment settings prior to commissioning the DG facility.

Additional Tests [ref. PSC 119.32]

The public utility or applicant may, upon reasonable notice, re-test the DG facility installation. The party requesting such retesting shall bear the cost of the retests.

NOTE: It is recommended that the applicant notify the electric provider if there is a malfunction of the DG facility and retesting is appropriate.

Appendix I Glossary

ANSI – American National Standards Institute.

Applicant — The legally responsible person applying to an electric provider to interconnect a DG facility to the electric provider's distribution system.

Application Review — A review by the electric provider of the completed standard interconnection application form for interconnection, to determine if an engineering review or distribution system study is needed.

Back-up Power — Electric energy or capacity supplied by an electric provider to replace energy ordinarily generated by DG facility equipment during an unscheduled outage of the distribution system.

Category 1 – A distributed generation facility of 20 kW or less.

Category 2 – A distributed generation facility of greater than 20 kW and not more than 200 kW.

Category 3 – A distributed generation facility of greater than 200 kW and not more than 1 MW.

Category 4 – A distributed generation facility of greater than 1 MW and not more than 15 MW.

Certified Equipment — A generating, control or protective system that has been certified by a nationally recognized testing laboratory (NRTL) as meeting acceptable safety and reliability standards.

Commission — The Public Service Commission of Wisconsin (PSCW).

Commissioning Test — The initial process of documenting and verifying the performance of a DG facility so that it operates in conformity with the design specifications.

Customer — Any person who is receiving electric service from an electric provider's distribution system.

Designated Point of Contact — Each electric provider shall designate one point of contact for all customer inquiries related to DG facilities and from which interested parties can obtain a copy of interconnection guidelines - which include the appropriate application forms and interconnection agreements.

Distributed Generation (DG) Facility — A facility for the generation of electricity with a capacity of no more than 15 megawatts that is located near the point where the electricity will be used or is in a location that will support the functioning of the electric power distribution grid.

Distribution Feeder — An electric line from an electric provider substation or other supply point to customers that is operated at 50 kV or less, or as determined by the commission.

Distribution System — All electrical wires, equipment, and other facilities owned or provided by an electric provider that are normally operated at 50 kV or less.

Distribution System Study — A study to determine if a distribution system upgrade is needed to accommodate the proposed DG facility and to determine the cost of any such upgrade.

Electric Provider — A public utility or retail electric cooperative that sells electricity at retail in Wisconsin.

Engineering Review — A study that may be undertaken by an electric provider, in response to its receipt of a completed standard application form for interconnection, to determine the suitability of the installation.

Fault — An equipment failure, conductor failure, short circuit, or other condition resulting from abnormally high amounts of current from the power source.

IEEE — Institute of Electrical and Electronics Engineers.

Independent System Operator (ISO) — An entity supervising the collective transmission facilities of a power region; the ISO is charged with nondiscriminatory coordination of market transactions, system-wide transmission planning, and network reliability. e.g., Midwest Independent System Operator (MISO)

Interconnection — The physical connection of a DG facility to the distribution system so that parallel operation can occur.

Interconnection Disconnect Switch — A mechanical device used to disconnect a DG facility from a distribution system. Also known as an isolation device.

Interconnection Guidelines — The means the "Wisconsin Distributed Generation Interconnection Guidelines". The interconnection guidelines are an advisory document for PSC 119 that will be available at the commission and at electric providers in either hard copy or electronic format.

Inverter — A machine, device or system that converts direct current power to alternating current power.

Islanding — A condition on the distribution system in which a DG facility delivers power to customers using a portion of the distribution system that is electrically isolated from the remainder of the distribution system.

kV – kilovolt.

kW – kilowatt.

MW – megawatt.

Make-Before-Break — Operational sequence of a transfer switch or relay where the new connection is made prior to disconnecting the existing connection.

Material Modification – Any modification that changes the maximum electrical output of a DG facility or changes the interconnection equipment, including:

a) Changing from certified to non-certified devices.

b) Replacing a component with a component of different functionality or UL listing.

Nationally Recognized Testing Laboratory — Any testing laboratory recognized by the U.S. Department of Labor Occupational Safety and Health Administration's (OSHA) accreditation program.

Note: A list of nationally recognized testing laboratories is available at www.osha.gov/dts/otpca/nrtl/index.html

Net Energy Billing — An arrangement where DG facilities can offset their associated load consumption and are compensated for any extra energy delivered to the electric provider at the rate as specified by their tariff. In Wisconsin only DG facilities using renewable resources with a capacity of 20 kW or less are eligible for net energy billing.

Network Service — Network service means two or more primary distribution feeders electrically connected on the low voltage side of two or more transformers, to form a single power source for any customer.

Parallel Operation — The operation, for longer than 100 milliseconds, of an on-site DG facility while the facility is connected to the energized distribution system.

Paralleling Equipment — The generating and protective equipment system that interfaces and synchronizes a DG facility with the distribution system.

Point of Common Coupling — The point where the electrical conductors of the distribution system are connected to the customer's conductors and where any transfer of electric power between the customer and the distribution system takes place.

Point of Interconnection — The point where the DG facility is electrically connected to the customer's electrical system.

Protective Function — A function of a DG facility, carried out using hardware and software, designed to prevent unsafe operating conditions from occurring before, during, and after the interconnection to a distribution system.

Public Utility — Defined in s. 196.01(5), Stats.

Qualifying Facility (QF) — Small power production facilities not owned by an electric provider, except hydroelectric located at a new dam or diversion, that utilizes at least 75% biomass, waste, renewable resources, or any combination of these as the primary energy source. There is typically no limitation on the size of the facility for wind, solar, or waste. Other facilities are typically less than 80 MW in size. An exact definition is found in 18 CFR, 292.203(a) of the Federal Energy Regulatory Commission's Regulations.

Standard Application Form — PSC Form 6027 for Category 1 DG facilities or PSC Form 6028 for Categories 2 to 4 DG facilities.

Standard Interconnection Agreement — PSC Form 6029 for Category 1 DG facilities or PSC Form 6030 for Categories 2 to 4 DG facilities.

Note: A copy of PSC Forms 6027 to 6030 can be obtained at no charge from your local electric provider or from the Public Service Commission, PO Box 7854, Madison, WI 53707-7854.

Supervisory Control and Data Acquisition (SCADA) — A system of remote control and telemetry used to monitor and control the electric system.

Switchgear — Components for switching, protecting, monitoring and controlling electric power systems.

Synchronize — The process of connecting two previously separated alternating current apparatuses after matching frequency, voltage, phase angles, etc. (e.g., paralleling a generator to the electric system).

Tariff ... for interconnection and parallel operation of DG facilities — Document setting out the terms and conditions for interconnection and parallel operation of a DG facility, as approved by the Public Service Commission of Wisconsin.

Telemetry — The transmission of DG operating data using telecommunications techniques.

Transfer Switch — A switch designed so that it will disconnect the load from one power source and reconnect it to another source.

UL — Underwriters Laboratories.

Unit — same as DG facility.

Wheeling — The contracted use of transmission (or less commonly distribution) facilities of one or more entities to transmit electricity for another entity.

Working Day — Defined in s. 227.01(14), WI Stats.

Appendix II

Protection System Function Reference

Basic Protection Functions (Category 1 related)

The following listing is short reference for the protection functions that prevent islanding and operation outside the specific power quality limits for DG facilities of 20 kW or less (Category 1). The ANSI device number is indicated for each protection function.

Synchronism Check (Function 25)

This function blocks out-of-phase closing and also prevents closing and energizing a dead low voltage bus by the generator.

Under-voltage (Function 27)

This function must be adjustable and have time delay to override system transients and clearing of external faults. All phase voltages shall be monitored with an under-voltage relay to provide maximum tripping reliability for three phase generators. Time under-voltage functions with inverse time characteristics are recommended.

Negative Sequence Overcurrent (Function 46)

Negative sequence overcurrent is used to increase sensitivity in the detection of unbalanced load and fault conditions (e.g., unbalanced generator loading or unsymmetrical types of faults on a feeder)

Over-current (Function 51)

This function serves as the main over current protection and is set to coordinate with the DG facility protection and any protection on the local load.

Over-voltage (Function 59)

This function must be adjustable and have a definite time delay to override system transients. All phase voltages shall be monitored with an over-voltage function to provide maximum tripping reliability for three phase generators.

Under-frequency (Function 81U)

An under frequency function with single set point.

Over-frequency (Function 81O)

An over-frequency function with a single set point.

Extended Protection Functions (Categories 2 – 4 related)

The following listing is short reference for the protection functions that prevent islanding and operation outside the specific power quality limits for DG facilities greater than 20 kW and not more than 15 MW (Categories 2 - 4). The ANSI device number is indicated for each protection function. The protective functions can be utilized for synchronous generators, induction generators, and inverters that are not certified. Some protection functions are not necessary for every generator type or transformer configuration (wye-wye, wye-delta, delta-wye, delta-delta). The ANSI function number is indicated for each protection function.

Phase Distance (Function 21)

Overexcitation (Function 24)

Synchronism Check (Function 25)

Undervoltage (Function 27)

Undervoltage (Function 27N)

Undervoltage Check (Function 27R)

3rd Harmonic Neutral Undervoltage (Function 27TN)

Directional Power (Function 32) [e.g., anti-motoring]

Loss of Field (Function 40) [e.g., excitation]

Negative Sequence Overcurrent (Function 46) [e.g., phase current unbalance]

Phase Sequence Voltage (Function 47)

Machine or Transformer Thermal (Function 49)

Instantaneous Overcurrent (Function 50)

Breaker Failure (Function 50BF)

Definite Time Overcurrent for Split-phase Differential (Function 50DT)

Instantaneous Ground Overcurrent (Function 50G)

Overcurrent (Function 51)

Ground Overcurrent (Function 51G)

Stator Ground Overcurrent (Function 51GNP)

Neutral Overcurrent (Function 51N)

Voltage Controlled Overcurrent (Function 51V) [e.g., time overcurrent with voltage restraint]

High-speed Overvoltage (Function 59I)

Overvoltage (Function 59N)

Time Overvoltage (Function 59T)

Voltage Balance (Function 60)

VT Fuse-loss Detection (Function 60FL)

100% Stator Ground Fault (Function 64G)

Phase Directional Overcurrent (Function 67)

Out-of-step (Function 78)

Reconnect Time Delay (Function 79)

Over and Underfrequency (Functions 81/O and 81/U)

Lockout (Function 86)

Phase Differential Current (Function 87S) [e.g., generator]

Spot Networks

Network Protector: ANSI/IEEE std. C57.12.44-1994

NOTES:

- a. Microprocessor based, multifunction protection systems (multifunction numeric packages) may be utilized instead of discrete relays if they meet the requirements for interconnection.
- b. Referenced standards:
 - ANSI/IEEE C37.90-1989 IEEE Standard for Relays and Relay Systems Associated with Electric Power Apparatus.
 - ANSI/IEEE C37.95-1989 IEEE Guide for Protective Relaying of Utility-Consumer Interconnections.

Appendix III Operating Limits, Power Quality, and Standards Summary

Operating Limits and Power Quality

Voltage

DG facilities should be operated in such a manner that the voltage levels on the distribution system remain in the same range as if the distributed generating were not connected to the distribution system. The DG facility should have an automatic method of disconnecting the generating equipment from the distribution system if a sustained voltage deviation is in excess of the following limits²:

- (1) For all retail service, except retail power service, the service voltage shall not vary by more than 5% above or below the standard voltage.
- (2) For retail power service furnished to customers having demands of 500 kilowatts or less, the service voltage shall be no more than 5% above or 10% below the standard nominal voltage.
- (3) For retail power service furnished to customers having demands of more than 500 kilowatts, the service voltage shall not vary by more than 10% above or 10% below the standard nominal voltage.

The DG facility may be reconnected when the distribution system voltage and frequency return to normal range and the system is stabilized.

Flicker

“Flicker” or “voltage flicker,” as defined by IEEE Standard 1100–1992, means a variation of input voltage sufficient in duration to allow visual observation of a change in electric light intensity. The DG facility should not cause excessive voltage flicker on the distribution system. If the source of the flicker is determined to be equipment operated by a specific applicant, the electric provider will notify the applicant and it shall be the applicant’s responsibility to correct the problem. If the problem is caused by the distribution system operating outside the limits set forth in s. PSC 113.0702, the responsible electric provider shall correct the problem.

Frequency

The operating frequency of the distributed generating equipment should not deviate more than +0.5 Hertz (Hz) or –0.7 Hz from a 60 Hz base. The DG facility should automatically be disconnected from the distribution system within 10 cycles if this frequency tolerance cannot be maintained. The DG facility may be reconnected when the distribution system voltage and frequency return to normal range and the system is stabilized.

Harmonics

The generating facility should be operated in a manner which does not produce undesirable levels of harmonics in the electric provider's power supply.

If the source of the harmonic distortion is determined to be equipment operated by the applicant, the electric provider shall notify the applicant and it shall be the applicant’s responsibility to correct the problem. When corrective action is necessary, guideline can be found in 1992 IEEE Standard 519.

² PSC 113.0702 Standard and maintenance of a service voltage.

Fault and Line Clearing

The DG facility should automatically disconnect from the electric provider's system upon activation of any of the protective functions. This ensures that the generator is disconnected from the distribution system prior to automatic re-close of breakers. The DG facility may be reconnected when the distribution system voltage and frequency return to normal range and the system is stabilized.

Voltage Transients

The magnitude of voltage transients (anywhere on the voltage waveform) caused by activation, deactivation or operation of the DG facility will not exceed twice the normal peak of the nominal voltage sine wave (e.g. 350 volts for a 120 volt rms system). No repetitive voltage transients causing false zero crossings of the voltage waveform will be allowed.

Noise

The level of noise should not be increased by more than 0.5% of the nominal system voltage (e.g. 0.6 volts on a 120 volt system) when the DG facility is operated.

Standards Summary

IEEE 1547 Summarized

The requirements of IEEE P1547 are summarized below for convenience. The reader is encouraged to consult the current complete text version of this standard.

- Voltage fluctuation at the point of interconnection during synchronization is limited to +5%.
- DC Injection Limits: 0.5% of rated output.
- Voltage Flicker: Cannot cause objectionable flicker to other customers. References IEEE 519 and IEC Technical Reports IEC 61000-3-7, IEC 61000-4-15, IEC 61400-21.
- Harmonics: Total harmonic current distortion 5%.
- Immunity Protection: Electromagnetic interference shall not cause disoperation of the interconnection system.
- Surge Capability: Meet IEEE/ANSI C62.41 and IEEE C37.90.1 for withstanding current and voltage surges.

IEEE 519 Summarized

The harmonic requirements of IEEE 519 are summarized below for convenience. The applicant is encouraged to consult the current version of this standard for the complete text describing requirements.

The objective of IEEE 519 is to limit the maximum individual frequency voltage harmonic to 3% of the fundamental frequency and the voltage Total Harmonic Distortion (THD) to 5% on the electric provider's side of the point of common coupling.

In addition, any voltage flicker resulting from the connection of the customer's energy producing equipment to the distribution system must not exceed the limits defined by the maximum permissible voltage fluctuations border line of visibility curve, identified in IEEE 519 (Figure 10.3). This requirement is necessary to minimize the adverse voltage effect upon other customers on the distribution system.

Underwriters Laboratories (UL):

UL is a private, not-for-profit organization that has evaluated products, materials and systems in the interest of public safety since 1894. UL has become the leading safety testing and certification organization in the U.S., and its label is found on products ranging from toaster ovens to inverters to some office furniture.

Although UL writes the testing procedures, other organizations may do the actual testing and certification of specific products. In addition to UL, other testing labs such as ETL SEMKO (ETL), and the Canadian Standards Association (CSA) are widely recognized listing agencies for electrical components.

- UL Standard 1741, *Inverters, Converters, and Controllers for Use in Independent Power Systems*, covers requirements and testing procedures for inverters, converters, charge controllers, and output controllers intended for use in stand-alone (not grid connected) or utility-interactive (grid-connected) power systems. Utility interactive inverters and converters are intended to be installed in parallel with an electric distribution system to supply common loads. UL 1741 comports to IEEE Std 929-2000, to cover inverters used for sources other than photovoltaics, and to cover controllers that might provide similar capabilities for synchronous and induction machines.
- UL Standard 2200, *Standard for Safety Stationary Engine Generator Assemblies*, covers stationary engine generator assemblies, including micro-turbines, rated at 600 volts or less.

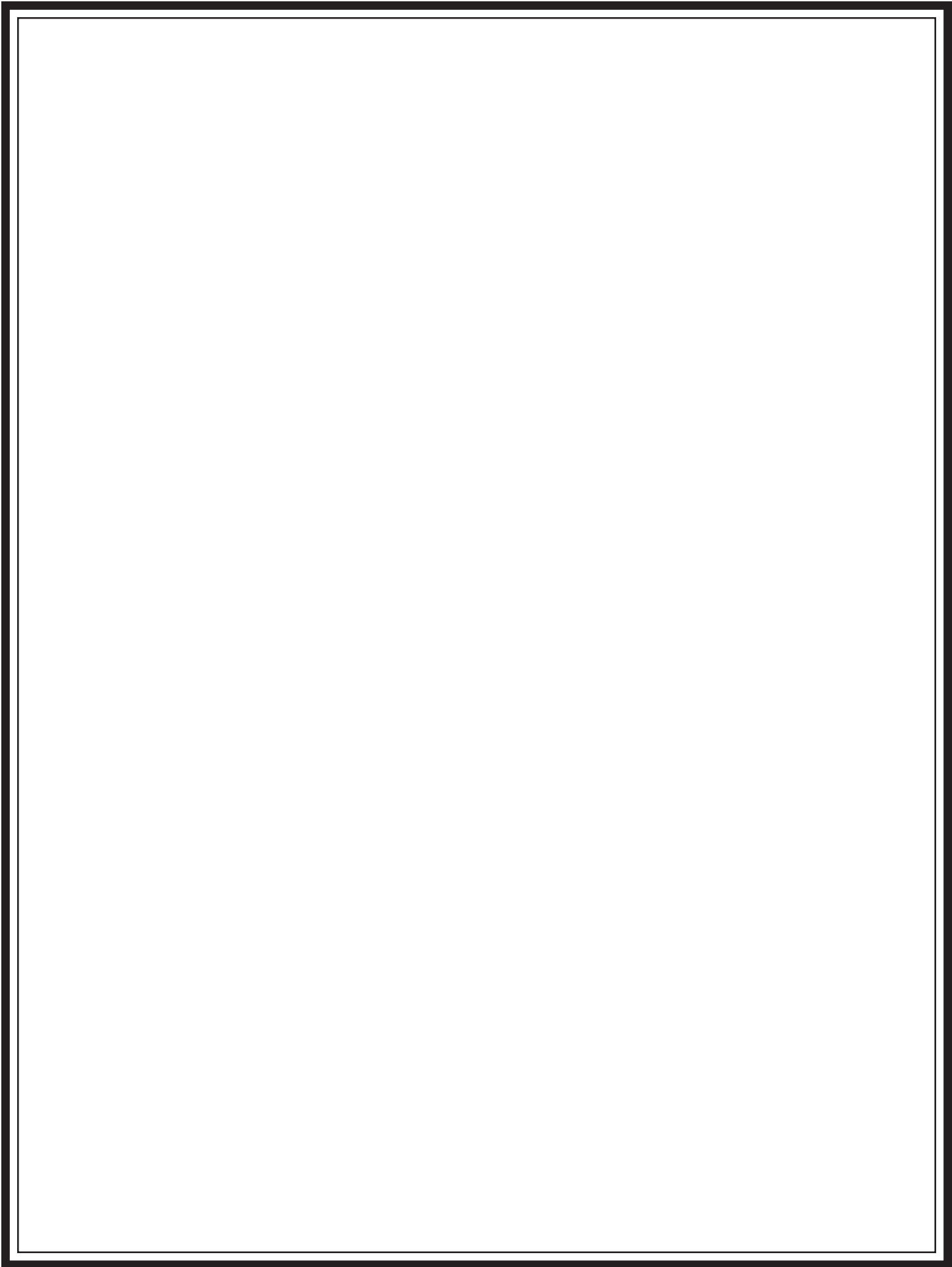



Clark Electric Cooperative

Greenwood, WI

DG One-line Schematic Diagram

Your Touchstone Energy® Partner



Appendix V Sample One-line Schematic Diagram (Category 1: 20 kW or less)

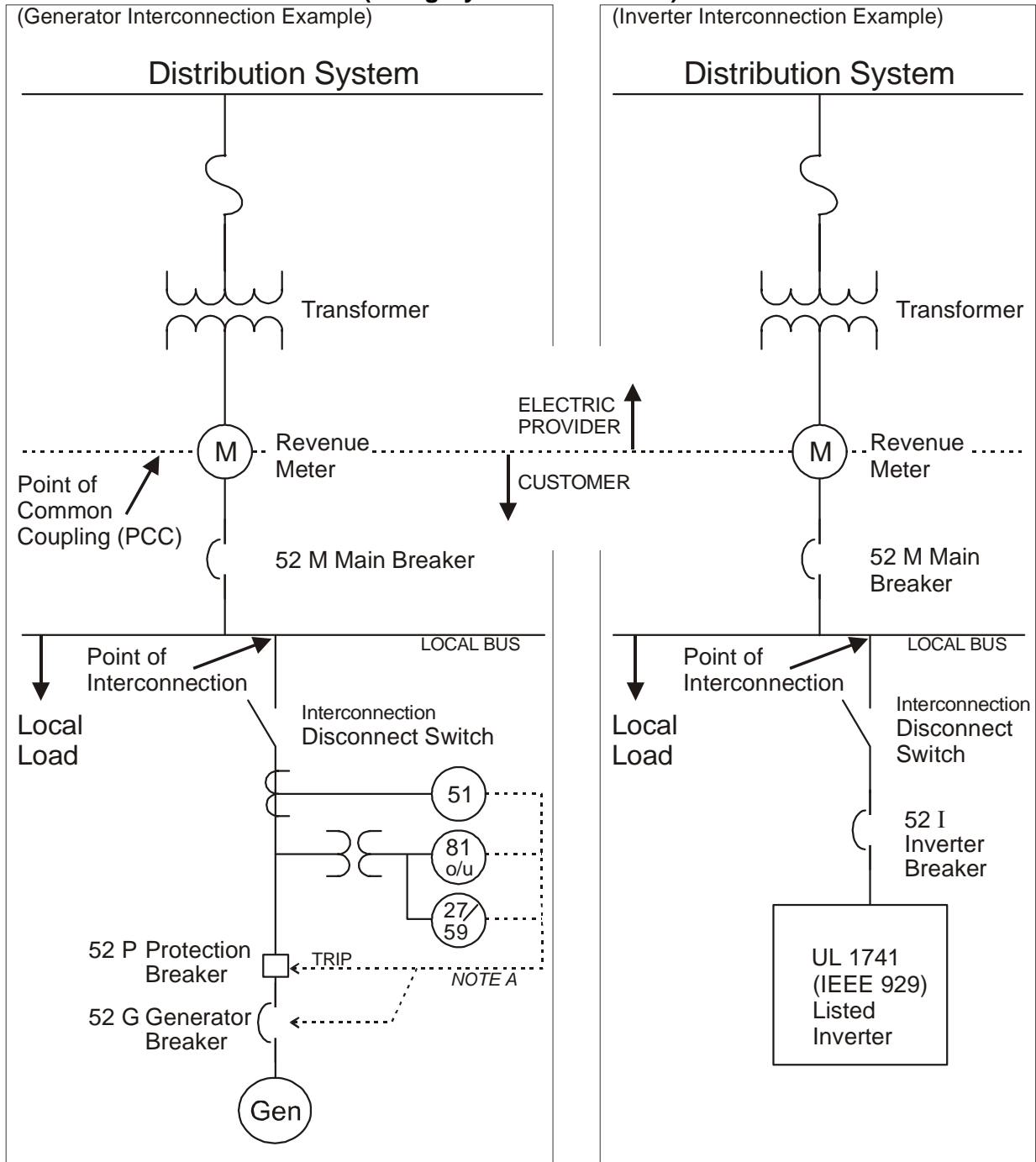

Relay Key:

- 27 / 59 under/over voltage relay
- 51 over current relay
- 52 circuit breaker
- 81 o/u over/under frequency relay

Indicate grounding configuration of generator or inverter transformer, if present, e.g.



Notes:

- A) Trip of either breaker is acceptable.



Clark Electric Cooperative

Greenwood, WI

**Chapter PSC 119
Rules For Interconnection
Of DG Facilities**

Your Touchstone Energy® Partner



Unofficial Text (See Printed Volume). Current through date and Register shown on Title Page.

Chapter PSC 119

RULES FOR INTERCONNECTING DISTRIBUTED GENERATION FACILITIES

Subchapter I — General

- PSC 119.01 Scope.
PSC 119.02 Definitions.

Subchapter II — General Requirements

- PSC 119.03 Designated point of contact.
PSC 119.04 Application process for interconnecting DG facilities.
PSC 119.05 Insurance and indemnification.
PSC 119.06 Modifications to the DG facility.
PSC 119.07 Easements and rights-of-way.
PSC 119.08 Fees and distribution system costs.
PSC 119.09 Disconnection.
PSC 119.10 One-line schematic diagram.
PSC 119.11 Control schematics.

- PSC 119.12 Site plan.

Subchapter III — Design Requirements

- PSC 119.20 General design requirements.
PSC 119.25 Minimum protection requirements.

Subchapter IV — Equipment Certification

- PSC 119.26 Certified paralleling equipment.
PSC 119.27 Non-certified paralleling equipment.

Subchapter V — Testing of DG Facility Installations

- PSC 119.30 Anti-islanding test.
PSC 119.31 Commissioning tests for paralleling equipment in Categories 2 to 4.
PSC 119.32 Additional test.
PSC 119.40 Right to appeal.

Subchapter I — General

PSC 119.01 Scope. This chapter implements s. 196.496, Stats. It applies to all DG facilities with a capacity of 15 MW or less that are interconnected, or whose owner seeks to have interconnected, to an electric public utility's distribution system. It also applies to all electric public utilities to whose distribution systems a DG facility is interconnected, or to which interconnection is sought. These rules establish uniform statewide standards for the interconnection of DG facilities to an electric distribution system.

History: CR 03-003; cr. Register January 2004 No. 577, eff. 2-1-04.

PSC 119.02 Definitions. In this chapter:

- (1) "ANSI" means American National Standards Institute.
- (2) "Applicant" means the legally responsible person applying to a public utility to interconnect a DG facility to the public utility's distribution system.
- (3) "Application review" means a review by the public utility of the completed standard application form for interconnection, to determine if an engineering review or distribution system study is needed.
- (4) "Category 1" means a DG facility of 20 kW or less.
- (5) "Category 2" means a DG facility of greater than 20 kW and not more than 200 kW.
- (6) "Category 3" means a DG facility of greater than 200 kW and not more than 1 MW.
- (7) "Category 4" means a DG facility of greater than 1 MW and not more than 15 MW.
- (8) "Certified equipment" means a generating, control or protective system that has been certified by a nationally recognized testing laboratory as meeting acceptable safety and reliability standards.
- (9) "Commission" means the public service commission of Wisconsin.
- (10) "Commissioning test" means the process of documenting and verifying the performance of a DG facility so that it operates in conformity with the design specifications.
- (11) "Customer" means any person who is receiving electric service from a public utility's distribution system.
- (12) "DG" means distributed generation.
- (13) "DG facility" has the meaning given in s. 196.496 (1), Stats.
- (14) "Distribution feeder" means an electric line from a public utility substation or other supply point to customers that is operated at 50 kV or less, or as determined by the commission.

(15) "Distribution system" means all electrical wires, equipment, and other facilities owned or provided by a public utility that are normally operated at 50 kV or less.

(16) "Distribution system study" means a study to determine if a distribution system upgrade is needed to accommodate the proposed DG facility and to determine the cost of any such upgrade.

(17) "Engineering review" means a study that may be undertaken by a public utility, in response to its receipt of a completed standard application form for interconnection, to determine the suitability of the installation.

(18) "Fault" means an equipment failure, conductor failure, short circuit, or other condition resulting from abnormally high amounts of current from the power source.

(19) "IEEE" means Institute of Electrical and Electronics Engineers.

(20) "Interconnection" means the physical connection of a DG facility to the distribution system so that parallel operation can occur.

(21) "Interconnection disconnect switch" means a mechanical device used to disconnect a DG facility from a distribution system.

(22) "Inverter" means a machine, device, or system that converts direct current power to alternating current power.

(23) "Islanding" means a condition on the distribution system in which a DG facility delivers power to customers using a portion of the distribution system that is electrically isolated from the remainder of the distribution system.

(24) "kV" means kilovolt.

(25) "kW" means kilowatt.

(26) "Material modification" means any modification that changes the maximum electrical output of a DG facility or changes the interconnection equipment, including:

- (a) Changing from certified to non-certified devices.
- (b) Replacing a component with a component of different functionality or UL listing.

(27) "MW" means megawatt.

(28) "Nationally recognized testing laboratory" means any testing laboratory recognized by the U.S. Department of Labor Occupational Safety and Health Administration's accreditation program.

Note: A list of nationally recognized testing laboratories is available at www.o-sha.gov/dts/otpcanrtl/index.html.

(29) "Network service" means 2 or more primary distribution feeders electrically connected on the low voltage side of 2 or more transformers, to form a single power source for any customer.

Appendix IV Codes and Standards

This appendix is a partial list of codes and standards referenced in the guidelines.

The National Fire Protection Association:

- *The National Electrical Code (NEC), (NFPA-70)*

Institute of Electrical and Electronics Engineers (IEEE):

- ANSI/IEEE C37.90-1989, *IEEE Standard for Relay Systems Associated with Electric Power Apparatus.*
- ANSI/IEEE C37.95-1989, *IEEE Guide for Protective Relaying of Utility-Consumer Interconnections.*
- ANSI C62.1, *Surge Arresters for AC Power Circuits.*
- ANSI C84.1-1989, *American National Standards for Electric Power Systems and Equipment Ratings (60 Hertz).* Establishes nominal voltage ratings and operating tolerances for 60 Hz electric power systems from 100 V through 230 kV.
- IEEE Std 142-1991, *IEEE Recommended Practice for Grounding of Industrial and Commercial Power Systems.*
- IEEE Std 242-1986, *Recommended Practice for Protection and Coordination of Industrial and Commercial Power Systems.*
- IEEE 519-1992, *IEEE Recommended Practices and Requirements for Harmonic Control in Electric Power Systems.*
- ANSI/IEEE Std. 929-2000, *Recommended Practice for Utility Interface of Photovoltaic (PV) Systems.*
- IEEE 1547, *Standard for Distributed Resources Interconnected with Electric Power Systems,* October 2003.
- IEEE P1547.1 (IEEE P1589), *Draft Standard for Conformance Test Procedures for Equipment Interconnecting Distributed Resources with Electric Power Systems.*
- IEEE P1547.2 (IEEE P1608), *Draft Application Guide for IEEE 1547 Standard for Interconnecting Distributed Resources with Electric Power Systems.*
- IEEE P1547.3, *Draft Guide for Monitoring Information Exchange and Control of DR Interconnected with Electric Power Systems.*
- IEEE P1561, *Draft Guide for Sizing Hybrid Stand-Alone Energy Systems*

(Inter-) National Electrical Testing Association (NETA):

NETA promotes the independent electrical testing industry by establishing testing standards and specifications and training and certifying testing technicians.

National Electrical Manufacturers Association (NEMA):

A nonprofit trade association supported by the manufacturers of electrical apparatus and supplies. NEMA is engaged in standardization to facilitate understanding between the manufacturers and users of electrical products.

State of Wisconsin

- Wisconsin Electrical Safety Code, Volume 1 and Volume 2
Volume 1: Department of Commerce - Comm 16 – State Electrical Code
Volume 2: Public Service Commission - PSC 114
- PSC 119: Public Service Commission of Wisconsin – “Rules for Interconnecting Distributed Generation Facilities”.

Unofficial Text (See Printed Volume). Current through date and Register shown on Title Page.

(30) "Parallel operation" means the operation, for longer than 100 milliseconds, of an on-site DG facility while the facility is connected to the energized distribution system.

(31) "Paralleling equipment" means the generating and protective equipment system that interfaces and synchronizes a DG facility with the distribution system.

(32) "Point of common coupling" means the point where the electrical conductors of the distribution system are connected to the customer's conductors and where any transfer of electric power between the customer and the distribution system takes place.

(33) "Public utility" has the meaning given in s. 196.01 (5), Stats.

(34) "Standard application form" means PSC Form 6027 for Category 1 DG facilities or PSC Form 6028 for Category 2 to 4 DG facilities.

(35) "Standard interconnection agreement" means PSC Form 6029 for Category 1 facilities or PSC Form 6030 for Category 2 to 4 DG facilities.

Note: A copy of PSC Forms 6027 to 6030 can be obtained at no charge from your local electric utility or from the Public Service Commission, PO Box 7854, Madison, WI 53707-7854.

(36) "Telemetry" means transmission of DG operating data using telecommunications techniques.

(37) "UL" means Underwriters Laboratory.

(38) "Working day" has the meaning given in s. 227.01 (14), Stats.

History: CR 03-003: cr. Register January 2004 No. 577, eff. 2-1-04.

Subchapter II — General Requirements

PSC 119.03 Designated point of contact. Each public utility shall designate one point of contact for all customer inquiries related to DG facilities and from which interested parties can obtain installation guidelines and the appropriate standard commission application and interconnection agreement forms. Each public utility shall have current information concerning its DG point of contact on file with the commission.

History: CR 03-003: cr. Register January 2004 No. 577, eff. 2-1-04.

PSC 119.04 Application process for interconnecting DG facilities. Public utilities and applicants shall complete the following steps regarding interconnection applications for all classes of DG facilities, in the order listed:

(1) The public utility shall respond to each request for DG interconnection by furnishing, within 5 working days, its guidelines and the appropriate standard application form.

(2) The applicant shall complete and submit the standard application form to its public utility.

(3) Within 10 working days of receiving a new or revised application, the public utility shall notify the applicant whether the application is complete.

(4) Within 10 working days of determining that the application is complete, the public utility shall complete its application review. If the public utility determines, on the basis of the application review that an engineering review is needed, it shall notify the applicant and state the cost of that review. For Categories 2 and 3, the cost estimate shall be valid for one year. For Category 4, the time period shall be negotiated but may not exceed one year. If the application review shows that an engineering review is not needed, the applicant may install the DG facility and need not complete the steps described in subs. (5) to (9).

(5) If the public utility determines on the basis of the application review that an engineering review is needed, upon receiving from the applicant written notification to proceed and receipt of applicable payment from the applicant, the public utility shall complete an engineering review and notify the applicant of the results within the following times:

(a) Category 1 DG application, 10 working days.

(b) Category 2 DG application, 15 working days.

(c) Category 3 DG application, 20 working days.

(d) Category 4 DG application, 40 working days.

(6) If the engineering review indicates that a distribution system study is necessary, the public utility shall include, in writing, a cost estimate in its engineering review. The cost estimate shall be valid for one year and the applicant shall have one year from receipt of the cost estimate in which to notify the public utility to proceed, except for a Category 4 DG application, in which case the time period shall be negotiated, but may not extend beyond one year. Upon receiving written notification to proceed and payment of the applicable fee, the public utility shall conduct the distribution system study.

(7) The public utility shall within the following time periods complete the distribution system study and provide study results to the applicant:

(a) Category 1 DG application, 10 working days.

(b) Category 2 DG application, 15 working days.

(c) Category 3 DG application, 20 working days.

(d) Category 4 DG application, 60 working days unless a different time period is mutually agreed upon.

(8) The public utility shall perform a distribution system study of the local distribution system and notify the applicant of findings along with any distribution system construction or modification costs to be borne by the applicant.

(9) If the applicant agrees, in writing, to pay for any required distribution system construction and modifications, the public utility shall complete the distribution system upgrades and the applicant shall install the DG facility within a time frame that is mutually agreed upon. The applicant shall notify the public utility when project construction is complete.

(10) (a) The applicant shall give the public utility the opportunity to witness or verify the system testing, as required in s. PSC 119.30 or 119.31. Upon receiving notification that an installation is complete, the public utility has 10 working days, for a Category 1 or 2 DG project, or 20 working days, for a Category 3 or 4 DG project, to complete the following:

1. Witness commissioning tests.

2. Perform an anti-islanding test or verify the protective equipment settings at its expense.

3. Waive its right, in writing, to witness or verify the commissioning tests.

(b) The applicant shall provide the public utility with the results of any required tests.

(11) The public utility may review the results of the on-site tests and shall notify the applicant within 5 working days, for a Category 1 DG project, or within 10 working days, for a Category 2 to 4 DG project, of its approval or disapproval of the interconnection. If approved, the public utility shall provide a written statement of final acceptance and cost reconciliation. Any applicant for a DG system that passes the commissioning test may sign a standard interconnection agreement and interconnect. If the public utility does not approve the interconnection, the applicant may take corrective action and request the public utility to reexamine its interconnection request.

(12) A standard interconnection agreement shall be signed by the applicant and public utility before parallel operation commences.

History: CR 03-003: cr. Register January 2004 No. 577, eff. 2-1-04.

PSC 119.05 Insurance and indemnification. (1) An applicant seeking to interconnect a DG facility to the distribution system of a public utility shall maintain liability insurance equal to or greater than the amounts stipulated in Table 119.05-1, per occurrence, or prove financial responsibility by another means mutually agreeable to the applicant and the public utility. For a

Unofficial Text (See Printed Volume). Current through date and Register shown on Title Page.

DG facility in Category 2 to 4, the applicant shall name the public utility as an additional insured party in the liability insurance policy.

| Category | Generation Capacity | Minimum Liability Insurance Coverage |
|----------|------------------------------|--------------------------------------|
| 1 | 20 kW or less | \$300,000 |
| 2 | Greater than 20 kW to 200 kW | \$1,000,000 |
| 3 | Greater than 200 kW to 1 MW | \$2,000,000 |
| 4 | Greater than 1 MW to 15 MW | Negotiated |

(2) Each party to the standard interconnection agreement shall indemnify, hold harmless and defend the other party, its officers, directors, employees and agents from and against any and all claims, suits, liabilities, damages, costs and expenses resulting from the installation, operation, modification, maintenance or removal of the DG facility. The liability of each party shall be limited to direct actual damages, and all other damages at law or in equity shall be waived.

History: CR 03-003: cr. Register January 2004 No. 577, eff. 2-1-04.

PSC 119.06 Modifications to the DG facility. The applicant shall notify the public utility of plans for any material modification to the DG facility by providing at least 20 working days of advance notice for a Category 1 DG facility, 40 working days for Category 2 DG facility, and 60 working days for a Category 3 or 4 DG facility. The applicant shall provide this notification by submitting a revised standard application form and such supporting materials as may be reasonably requested by the public utility. The applicant may not commence any material modification to the DG facility until the public utility has approved the revised application, including any necessary engineering review or distribution system study. The public utility shall indicate its written approval or rejection of a revised application within the number of working days shown in the table below. Upon completion of the application process, a new standard interconnection agreement shall be signed by both parties prior to parallel operation. If the public utility fails to respond in the time specified in Table 119.06-1, the completed application is deemed approved.

| Category | Generation Capacity | Application Review Fee | Engineering Review Fee | Distribution System Study Fee |
|----------|------------------------------|------------------------|------------------------|-------------------------------|
| 1 | 20 kW or less | None | None | None |
| 2 | Greater than 20 kW to 200 kW | \$250 | Max. \$500 | Max. \$500 |
| 3 | Greater than 200 kW to 1 MW | \$500 | Cost based | Cost based |
| 4 | Greater than 1 MW to 15 MW | \$1000 | Cost based | Cost based |

(2) The public utility may recover from the applicant an amount up to the actual cost, for labor and parts, of any distribution system upgrades required. No public utility may charge a commissioning test fee for initial start-up of the DG facility. The utility may charge for retesting an installation that does not conform to the requirements set forth in this chapter.

(3) Costs for any necessary line extension shall be assessed pursuant to s. PSC 113.1005.

History: CR 03-003: cr. Register January 2004 No. 577, eff. 2-1-04.

PSC 119.09 Disconnection. A public utility may refuse to connect or may disconnect a DG facility from the distribution

| Category | Generation Capacity after Modification | Working Days for Utility's Response to Proposed Modifications |
|----------|--|---|
| 1 | 20 kW or less | 20 |
| 2 | Greater than 20 kW to 200 kW | 40 |
| 3 | Greater than 200 kW to 1 MW | 60 |
| 4 | Greater than 1 MW to 15 MW | 60 |

History: CR 03-003: cr. Register January 2004 No. 577, eff. 2-1-04.

PSC 119.07 Easements and rights-of-way. If a public utility line extension is required to accommodate a DG interconnection, the applicant shall provide, or obtain from others, suitable easements or rights-of-way. The applicant is responsible for the cost of providing or obtaining these easements or rights of way.

History: CR 03-003: cr. Register January 2004 No. 577, eff. 2-1-04.

PSC 119.08 Fees and distribution system costs.

(1) Upon receiving a standard application form, the public utility shall specify the amount of any engineering review or distribution system study fees. Application fees shall be credited toward the cost of any engineering review or distribution system study. The applicant shall pay the fees specified in Table 119.08, unless the public utility chooses to waive the fees in whole or in part.

system only under any of the following conditions:

- (1) Lack of approved standard application form or standard interconnection agreement.
- (2) Termination of interconnection by mutual agreement.
- (3) Non-compliance with the technical or contractual requirements.
- (4) Distribution system emergency.
- (5) Routine maintenance, repairs, and modifications, but only for a reasonable length of time necessary to perform the required work and upon reasonable notice.

History: CR 03-003: cr. Register January 2004 No. 577, eff. 2-1-04.

Unofficial Text (See Printed Volume). Current through date and Register shown on Title Page.**PSC 119.10 One-line schematic diagram.**

(1) The applicant shall include a one-line schematic diagram with the completed standard application form. ANSI symbols shall be used in the one-line schematic diagram to show the following:

- (a) Generator or inverter.
- (b) Point where the DG facility is electrically connected to the customer's electrical system.
- (c) Point of common coupling.
- (d) Lockable interconnection disconnect switch.
- (e) Method of grounding, including generator and transformer ground connections.
- (f) Protection functions and systems.

(2) The applicant shall include with the schematic diagram technical specifications of the point where the DG facility is electrically connected to the customer's electrical system, including all anti-islanding and power quality protective systems. The specifications regarding the anti-islanding protective systems shall describe all automatic features provided to disconnect the DG facility from the distribution system in case of loss of grid power, including the functions for over/under voltage, over/under frequency, overcurrent, and loss of synchronism. The applicant shall also provide technical specifications for the generator, lockable interconnection disconnect switch, and grounding and shall attach the technical specification sheets for any certified equipment. The applicant shall include with the schematic diagram a statement by the manufacturer that its equipment meets or exceeds the type tested requirements for certification.

History: CR 03-003; cr. Register January 2004 No. 577, eff. 2-1-04.

PSC 119.11 Control schematics. For equipment not certified under s. PSC 119.26, the applicant shall include with the application a complete set of control schematics showing all protective functions and controls for generator protection and distribution system protection.

History: CR 03-003; cr. Register January 2004 No. 577, eff. 2-1-04.

PSC 119.12 Site plan. For all categories, the applicant shall include with the application a site plan that shows the location of the interconnection disconnect switch, adjoining street name, and the street address of the DG facility. For Category 2, 3, or 4 DG facilities, the site plan shall show the location of major equipment, electric service entrance, electric meter, interconnection disconnect switch, and interface equipment.

History: CR 03-003; cr. Register January 2004 No. 577, eff. 2-1-04.

Subchapter III — Design Requirements

PSC 119.20 General design requirements. (1) The applicant shall install protection devices to ensure that the current supplied by the DG facility is interrupted if a fault or other potentially dangerous event occurs on the distribution system. If such an event occurs and the public utility's distribution system is de-energized, any DG facility that is connected to this distribution system shall automatically disconnect. All DG facilities shall utilize protection devices that prevent electrically closing a DG facility that is out of synchronization with the distribution system.

(2) All installations shall include equipment circuit breakers, on the DG facility side of the point where the DG facility is electrically connected to the customer's electrical system, that are capable of interrupting the maximum available fault current. Equipment circuit breakers shall meet all applicable UL, ANSI, and IEEE standards.

(3) The public utility may require that the applicant furnish and install an interconnection disconnect switch that opens, with a visual break, all ungrounded poles of the interconnection circuit. The interconnection disconnect switch shall be rated for the voltage and fault current requirements of the DG facility, and shall meet all applicable UL, ANSI, and IEEE standards. The switch

enclosure shall be properly grounded. The interconnection disconnect switch shall be accessible at all times, located for ease of access to public utility personnel, and shall be capable of being locked in the open position. The applicant shall follow the public utility's recommended switching, clearance, tagging, and locking procedures.

Note: Provisions of the Wisconsin Electrical Safety Code, Volume 2, ch. Comm 16 also apply to these installations.

(4) The applicant shall label the interconnection disconnect switch "Interconnection Disconnect Switch" by means of a permanently attached sign with clearly visible and permanent letters. The applicant shall provide and post its procedure for disconnecting the DG facility next to the switch.

(5) The applicant shall install an equipment grounding conductor, in addition to the ungrounded conductors, between the DG facility and the distribution system. The grounding conductors shall be available, permanent, and electrically continuous, shall be capable of safely carrying the maximum fault likely to be imposed on them by the systems to which they are connected, and shall have sufficiently low impedance to facilitate the operation of overcurrent protection devices under fault conditions. All DG transformations shall be multi-grounded. The DG facility may not be designed or implemented such that the earth becomes the sole fault current path.

Note: Grounding practices are also regulated by the Wisconsin Electrical Safety Code Volumes 1 and 2, as found in chs. Comm 16 and PSC 114.

(6) (a) Certified paralleling equipment shall conform to UL 1741 (January 17, 2001 Revision) or an equivalent standard as determined by the commission.

(b) Non-certified paralleling equipment shall conform to the requirements of IEEE 1547.

Note: The UL standards are available at <http://ulstandardsinfontet.ul.com>, and IEEE standards are available at <http://iee.org>. They may also be viewed at the PSCW Library, 610 N. Whitney Way, Madison, WI.

(7) (a) All Category 1 and 2 DG facilities shall be operated at a power factor greater than 0.9.

(b) All Category 3 and 4 DG facilities shall be operated at unity power factor or as mutually agreed between the public utility and applicant.

(8) The DG facility shall not create system voltage or current disturbances that exceed the standards listed in subch. VII of ch. PSC 113.

(9) The applicant shall protect and synchronize its DG facility with the distribution system.

(10) Each DG facility shall include an automatic interrupting device that is listed with a nationally recognized testing laboratory and is rated to interrupt available fault current. The interrupting device shall be tripped by any of the required protective functions.

(11) An applicant for interconnection of a Category 3 or Category 4 facility shall provide test switches as specified by the public utility, to allow for testing the operation of the protective functions without unwiring or disassembling the equipment.

(12) The public utility may require a DG facility to be isolated from other customers by installation of a separate power transformer. When a separate transformer is required, the utility may include its actual cost in the distribution system upgrade costs. The applicant is responsible for supplying and paying for any custom transformer. This requirement does not apply to an induction-type generator with a capacity of 5 kW or less, or to other generating units of 10 kW or less that utilize a line-commutated inverter.

(13) The owner of a DG facility designed to operate in parallel with a spot or secondary network service shall provide relaying or control equipment that is rated and listed for the application and is acceptable to the public utility.

(14) For a Category 3 or Category 4 DG facility, the public utility may require that the facility owner provide telemetry equipment whose monitoring functions include transfer-trip function-

Unofficial Text (See Printed Volume). Current through date and Register shown on Title Page.

ality, voltage, current, real power (watts), reactive power (vars), and breaker status.

History: CR 03-003: cr. Register January 2004 No. 577, eff. 2-1-04.

PSC 119.25 Minimum protection requirements.

(1) Each DG facility shall include protection and anti-islanding equipment to prevent the facility from adversely affecting the reliability or capability of the distribution system. The applicant shall contact the public utility to determine any specific protection requirements.

(2) The protective system functions, which may be met with microprocessor-based multifunction protection systems or discrete relays, are required. Protective relay activation shall not only alarm but shall also trip the generator breaker/contact.

(3) In addition to anti-islanding protection, a DG facility shall meet the following minimum protection requirements:

(a) A Category 1 DG facility shall include:

1. Over/under frequency function.
2. Over/under voltage function.
3. Overcurrent function.
4. Ground fault protection.

(b) A Category 2, 3, or 4 DG facility shall include:

1. Over/under frequency function.
2. Over/under voltage function.
3. Overcurrent function.
4. Ground fault protection.
5. Synchronism check function.
6. Other equipment, such as other protective devices, supervisory control and alarms, telemetry and associated communications channel, that the public utility determines to be necessary.

The public utility shall advise the applicant of any communications requirements after a preliminary review of the proposed installation.

(4) A DG facility certified pursuant to s. PSC 119.26 shall be deemed to meet the requirements of this section.

History: CR 03-003: cr. Register January 2004 No. 577, eff. 2-1-04.

Subchapter IV — Equipment Certification

PSC 119.26 Certified paralleling equipment. DG paralleling equipment that a nationally recognized testing laboratory certifies as meeting the applicable type testing requirements of UL 1741 (January 17, 2001 revision) is acceptable for interconnection, without additional protection systems, to the distribution system. The applicant may use certified paralleling equipment for interconnection to a distribution system without further review or testing of the equipment design by the public utility, but the use of this paralleling equipment does not automatically qualify the applicant to be interconnected to the distribution system at any point in the distribution system. The public utility may still require an engineering review to determine the compatibility of the distributed generation system with the distribution system capabilities at the selected point of common coupling.

History: CR 03-003: cr. Register January 2004 No. 577, eff. 2-1-04.

PSC 119.27 Non-certified paralleling equipment.

(1) Any DG facility that is not certified under s. PSC 119.26 shall be equipped with protective hardware or software to prevent islanding and to maintain power quality. The applicant shall provide the final design of this protective equipment. The public utility may review and approve the design, types of protective functions, and the implementation of the installation. The applicant shall own the protective equipment installed at its facility.

(2) The applicant shall calibrate any protective system approved under sub.(1) to the specifications of the public utility. The applicant shall obtain prior written approval from the public utility for any revisions to specified protection system calibrations.

History: CR 03-003: cr. Register January 2004 No. 577, eff. 2-1-04.

Subchapter V — Testing of DG Facility Installations

PSC 119.30 Anti-islanding test. The public utility may perform an anti-islanding test or observe the automatic shutdown before giving final written approval for interconnection of the DG facility. The anti-islanding test requires that the unit shut down upon sensing the loss of power on the distribution system. This can be simulated by either removing the customer meter or opening a disconnection switch while the generator is operating. Voltage across the customer side of the meter or disconnection switch shall be measured and must be observed to reduce to zero within two seconds after disconnection. The test shall be conducted with the generation as close to its full output as possible. If a voltage is sustained after the disconnection, approval of the installation shall not be given until corrective measures are taken with a subsequent successful shutdown test.

History: CR 03-003: cr. Register January 2004 No. 577, eff. 2-1-04.

PSC 119.31 Commissioning tests for paralleling equipment in Categories 2 to 4. The public utility shall provide the acceptable range of settings for the paralleling equipment of a Category 2, 3, or 4 DG facility. The applicant shall program protective equipment settings into this paralleling equipment. The public utility may verify the protective equipment settings prior to allowing the DG facility to interconnect to the distribution system.

History: CR 03-003: cr. Register January 2004 No. 577, eff. 2-1-04.

PSC 119.32 Additional test. The public utility or applicant may, upon reasonable notice, re-test the DG facility installation. The party requesting such re-testing shall bear the cost of the re-tests.

History: CR 03-003: cr. Register January 2004 No. 577, eff. 2-1-04.

PSC 119.40 Right to appeal. The owner of a generating facility interconnected or proposed to be interconnected with a utility system may appeal to the commission should any requirement of the utility service rules filed in accordance with the provisions of this chapter be considered excessive or unreasonable. Such appeal will be reviewed and the customer notified of the commission's determination.

History: CR 03-003: renum. from PSC 113.0208 and am. Register January 2004 No. 577, eff. 2-1-04.

